

## General Description

SFGMOS<sup>®</sup> MOSFET is based on Oriental Semiconductor's unique device design to achieve low  $R_{DS(ON)}$ , low gate charge, fast switching and excellent avalanche characteristics. The high  $V_{th}$  series is specially optimized for high systems with gate driving voltage greater than 10V.

## Features

- Low  $R_{DS(ON)}$  & FOM
- Extremely low switching loss
- Excellent stability and uniformity
- Fast switching and soft recovery



## Applications

- Switched mode power supply
- Motor driver
- Battery protection
- DC-DC convertor
- Solar inverter
- UPS and energy inverter

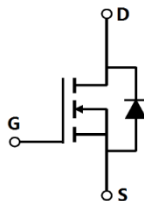
## Key Performance Parameters

Parameter	Value	Unit
$V_{DS, min} @ T_{j(max)}$	80	V
$I_{D, pulse}$	390	A
$R_{DS(ON), max} @ V_{GS}=10V$	4.5	m $\Omega$
$Q_g$	101.6	nC

## Marking Information

Product Name	Package	Marking
SFG130N08KF	TO263	SFG130N08K

## Package & Pin information



**Absolute Maximum Ratings** at  $T_j=25^\circ\text{C}$  unless otherwise noted

Parameter	Symbol	Value	Unit
Drain source voltage	$V_{DS}$	80	V
Gate source voltage	$V_{GS}$	$\pm 20$	V
Continuous drain current <sup>1)</sup> , $T_C=25^\circ\text{C}$	$I_D$	130	A
Pulsed drain current <sup>2)</sup> , $T_C=25^\circ\text{C}$	$I_{D, pulse}$	390	A
Continuous diode forward current <sup>1)</sup> , $T_C=25^\circ\text{C}$	$I_S$	130	A
Diode pulsed current <sup>2)</sup> , $T_C=25^\circ\text{C}$	$I_{S, pulse}$	390	A
Power dissipation <sup>3)</sup> , $T_C=25^\circ\text{C}$	$P_D$	192	W
Single pulsed avalanche energy <sup>5)</sup>	$E_{AS}$	400	mJ
Operation and storage temperature	$T_{stg}, T_j$	-55 to 150	$^\circ\text{C}$

**Thermal Characteristics**

Parameter	Symbol	Value	Unit
Thermal resistance, junction-case	$R_{\theta JC}$	0.65	$^\circ\text{C/W}$
Thermal resistance, junction-ambient <sup>4)</sup>	$R_{\theta JA}$	62	$^\circ\text{C/W}$

**Electrical Characteristics** at  $T_j=25^\circ\text{C}$  unless otherwise specified

Parameter	Symbol	Min.	Typ.	Max.	Unit	Test condition
Drain-source breakdown voltage	$BV_{DSS}$	80			V	$V_{GS}=0\text{ V}, I_D=250\ \mu\text{A}$
Gate threshold voltage	$V_{GS(th)}$	2.0		4.0	V	$V_{DS}=V_{GS}, I_D=250\ \mu\text{A}$
Drain-source on-state resistance	$R_{DS(ON)}$		3.8	4.5	$\text{m}\Omega$	$V_{GS}=10\text{ V}, I_D=20\text{ A}$
Gate-source leakage current	$I_{GSS}$			100	nA	$V_{GS}=20\text{ V}$
				-100		$V_{GS}=-20\text{ V}$
Drain-source leakage current	$I_{DSS}$			1	$\mu\text{A}$	$V_{DS}=80\text{ V}, V_{GS}=0\text{ V}$

### Dynamic Characteristics

Parameter	Symbol	Min.	Typ.	Max.	Unit	Test condition
Input capacitance	$C_{iss}$		8681		pF	$V_{GS}=0\text{ V}$ , $V_{DS}=50\text{ V}$ , $f=1\text{ MHz}$
Output capacitance	$C_{oss}$		6484		pF	
Reverse transfer capacitance	$C_{rss}$		8.55		pF	
Turn-on delay time	$t_{d(on)}$		28.2		ns	$V_{GS}=10\text{ V}$ , $V_{DS}=50\text{ V}$ , $R_G=2.2\ \Omega$ , $I_D=22\text{ A}$
Rise time	$t_r$		7.5		ns	
Turn-off delay time	$t_{d(off)}$		81.9		ns	
Fall time	$t_f$		20.1		ns	

### Gate Charge Characteristics

Parameter	Symbol	Min.	Typ.	Max.	Unit	Test condition
Total gate charge	$Q_g$		101.6		nC	$V_{GS}=10\text{ V}$ , $V_{DS}=50\text{ V}$ , $I_D=22\text{ A}$
Gate-source charge	$Q_{gs}$		20.6		nC	
Gate-drain charge	$Q_{gd}$		28.7		nC	
Gate plateau voltage	$V_{plateau}$		4.2		V	

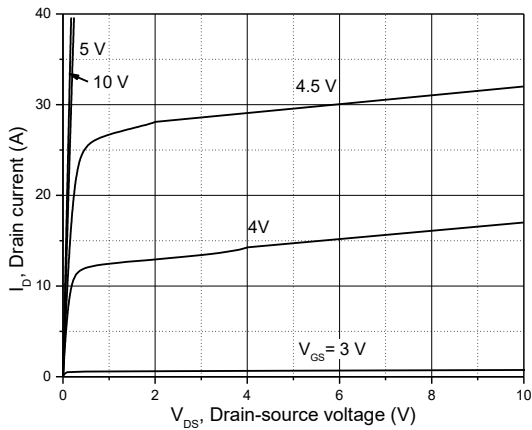
### Body Diode Characteristics

Parameter	Symbol	Min.	Typ.	Max.	Unit	Test condition
Diode forward voltage	$V_{SD}$			1.3	V	$I_S=20\text{ A}$ , $V_{GS}=0\text{ V}$
Reverse recovery time	$t_{rr}$		82.1		ns	$V_R=50\text{ V}$ , $I_S=10\text{ A}$ , $di/dt=100\text{ A}/\mu\text{s}$
Reverse recovery charge	$Q_{rr}$		248.4		nC	
Peak reverse recovery current	$I_{rrm}$		4.9		A	

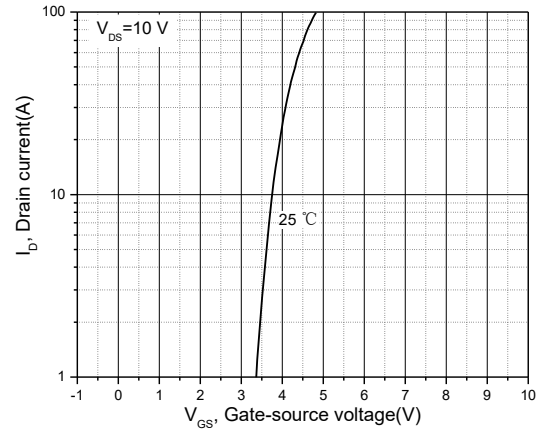
### Note

- 1) Calculated continuous current based on maximum allowable junction temperature.
- 2) Repetitive rating; pulse width limited by max. junction temperature.
- 3)  $P_d$  is based on max. junction temperature, using junction-case thermal resistance.
- 4) The value of  $R_{\theta JA}$  is measured with the device mounted on 1 in 2 FR-4 board with 2oz. Copper, in a still air environment with  $T_a=25\text{ }^\circ\text{C}$ .
- 5)  $V_{DD}=50\text{ V}$ ,  $V_{GS}=10\text{ V}$ ,  $L=0.3\text{ mH}$ , starting  $T_j=25\text{ }^\circ\text{C}$ .

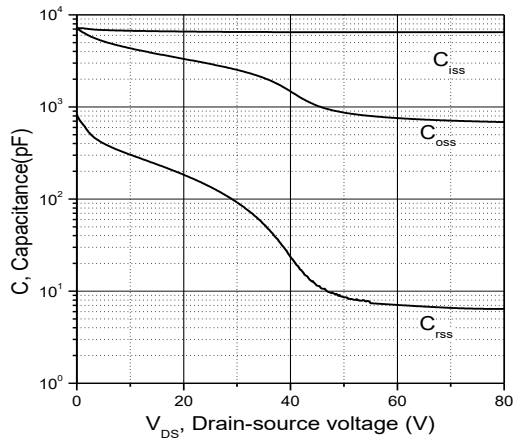
**Electrical Characteristics Diagrams**



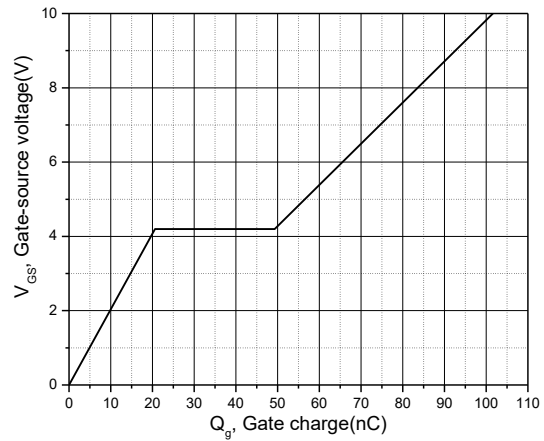
**Figure 1. Typ. output characteristics**



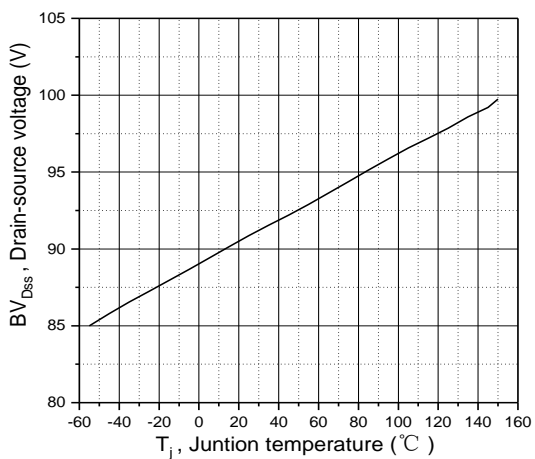
**Figure 2. Typ. transfer characteristics**



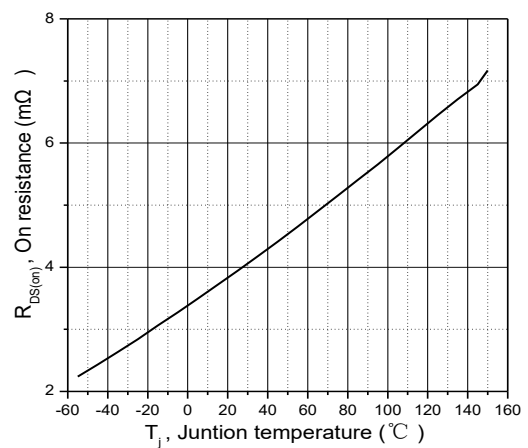
**Figure 3. Typ. capacitances**



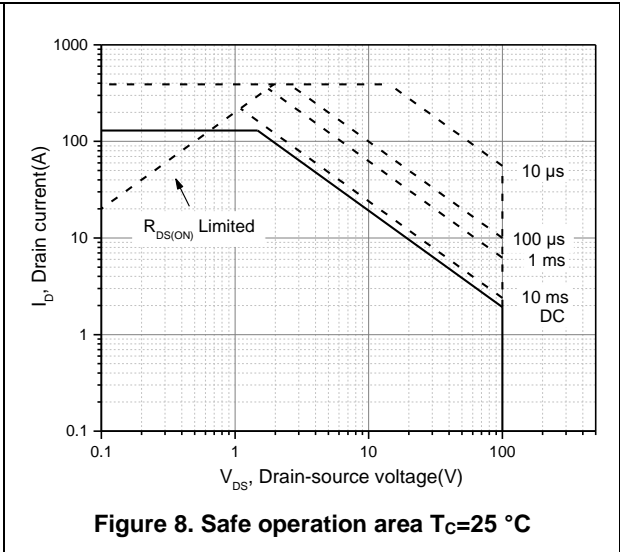
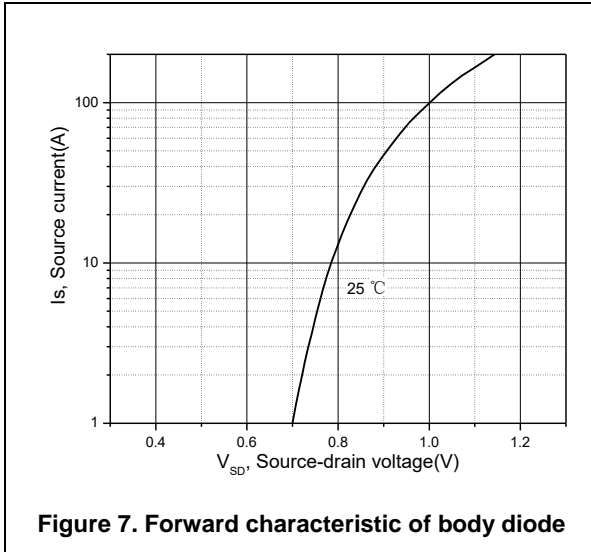
**Figure 4. Typ. gate charge**



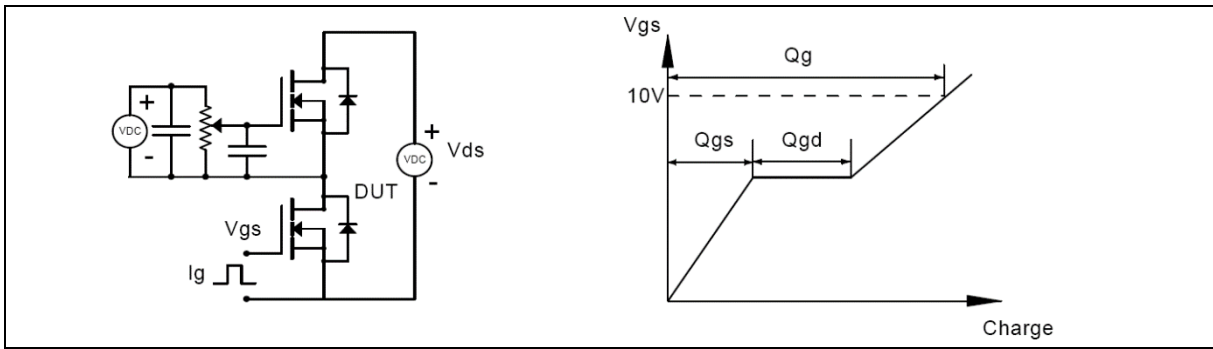
**Figure 5. Drain-source breakdown voltage**



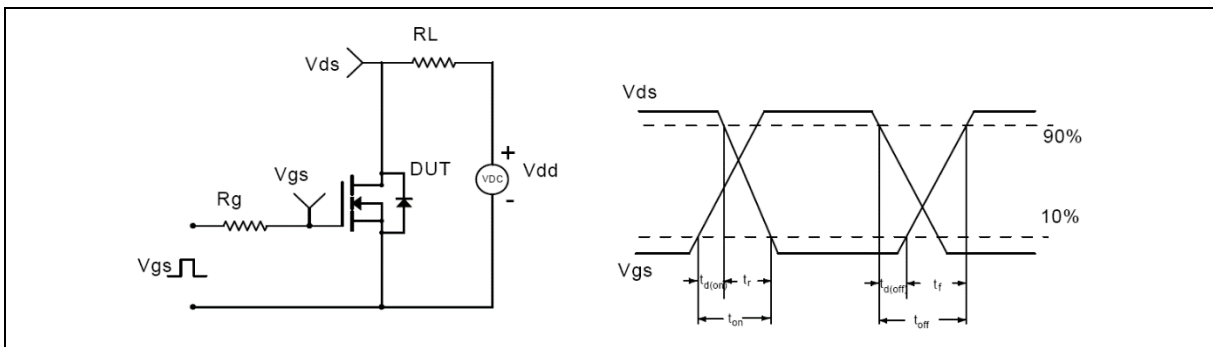
**Figure 6. Drain-source on-state resistance**



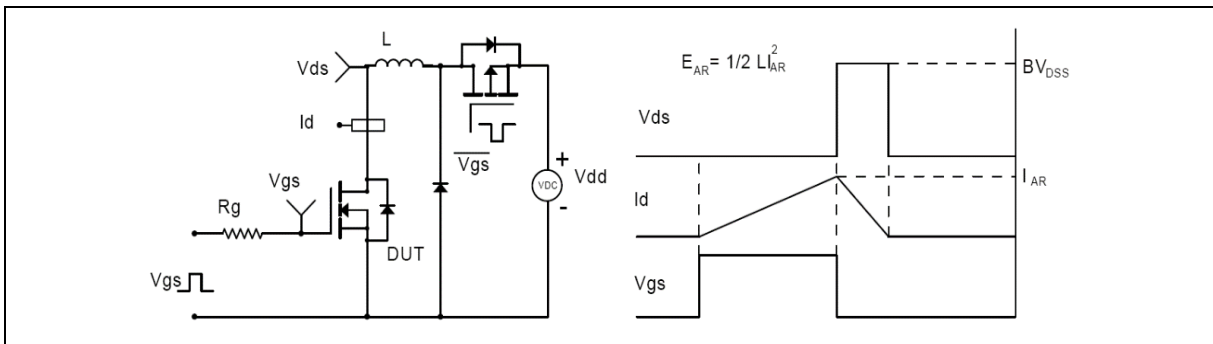
**Test circuits and waveforms**



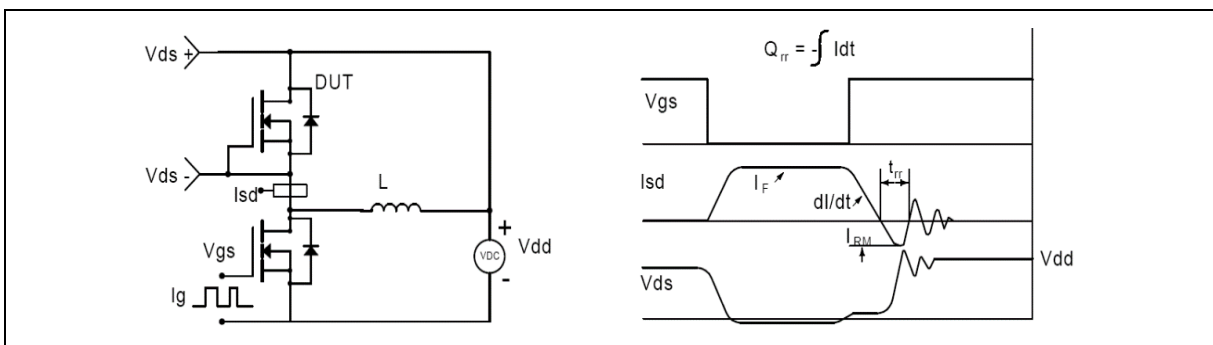
**Figure 1. Gate charge test circuit & waveform**



**Figure 2. Switching time test circuit & waveforms**

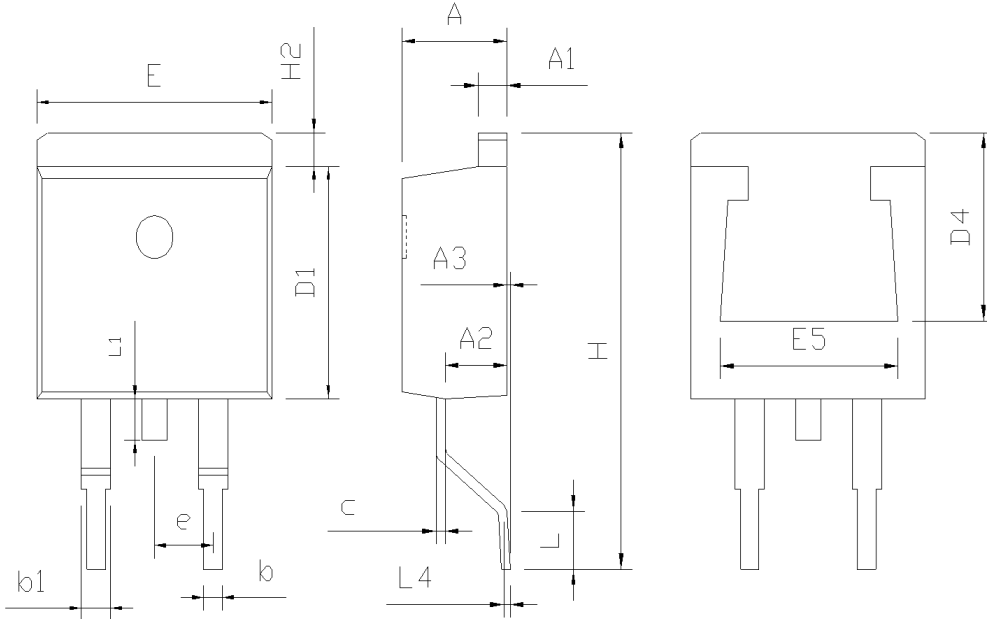


**Figure 3. Unclamped inductive switching (UIS) test circuit & waveforms**



**Figure 4. Diode reverse recovery test circuit & waveforms**

**Package Information**



Symbol	mm		
	Min	Nom	Max
A	4.37	4.57	4.77
A1	1.22	1.27	1.42
A2	2.49	2.69	2.89
A3	0.00	0.13	0.25
b	0.70	0.81	0.96
b1	0.17	1.27	1.47
c	0.30	0.38	0.53
D1	8.50	8.70	8.90
D4	6.60	-	-
E	9.86	10.16	10.36
E5	7.06	-	-
e	2.54 BSC		
H	14.70	15.10	15.50
H2	1.07	1.27	1.47
L2	2.00	2.30	2.60
L1	1.40	1.55	1.70
L4	0.25 BSC		

Version 1: TO263-C package outline dimension

## Ordering Information

Package Type	Units/ Reel	Reels / Inner Box	Units/ Inner Box	Inner Boxes/ Carton Box	Units/ Carton Box
TO263-C	800	1	800	5	4000

## Product Information

Product	Package	Pb Free	RoHS	Halogen Free
SFG130N08KF	TO263	yes	yes	yes

## Legal Disclaimer

The information given in this document shall in no event be regarded as a guarantee of conditions or characteristics. With respect to any examples or hints given herein, any typical values stated herein and/or any information regarding the application of the device, Oriental Semiconductor hereby disclaims any and all warranties and liabilities of any kind, including without limitation, warranties of non-infringement of intellectual property rights of any third party.

For further information on technology, delivery terms and conditions and prices, please contact the Oriental Semiconductor sales representatives ([www.orientalsemi.com](http://www.orientalsemi.com)).

© Oriental Semiconductor Co.,Ltd. All Rights Reserved 