

## General Description

The GreenMOS<sup>®</sup> high voltage MOSFET utilizes charge balance technology to achieve outstanding low on-resistance and lower gate charge. It is engineered to minimize conduction loss, provide superior switching performance and robust avalanche capability.

The GreenMOS<sup>®</sup> S series is optimized for its switching characteristics to achieve aggressive EMI standards. It is easy to use for smaller power supply systems to meet the both efficiency and EMI standards.

## Features

- Low  $R_{DS(ON)}$  & FOM
- Extremely low switching loss
- Excellent stability and uniformity

**GreenMOS<sup>®</sup>**



## Applications

- LED lighting
- Charger
- Adapter
- Telecom power
- Server power
- Solar/UPS

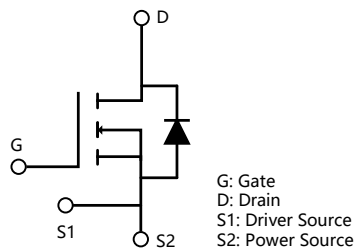
## Key Performance Parameters

Parameter	Value	Unit
$V_{DS, min} @ T_{j(max)}$	650	V
$I_{D, pulse}$	60	A
$R_{DS(ON), max} @ V_{GS}=10V$	200	m $\Omega$
$Q_g$	72.9	nC

## Marking Information

Product Name	Package	Marking
OSG60R200JSZF	PDFN8*8	OSG60R200JSZ

## Package & Pin Information



**Absolute Maximum Ratings** at  $T_j=25^\circ\text{C}$  unless otherwise noted

Parameter	Symbol	Value	Unit
Drain-source voltage	$V_{DS}$	600	V
Gate-source voltage	$V_{GS}$	$\pm 30$	V
Continuous drain current <sup>1)</sup> , $T_C=25^\circ\text{C}$	$I_D$	20	A
Continuous drain current <sup>1)</sup> , $T_C=100^\circ\text{C}$		12.6	
Pulsed drain current <sup>2)</sup> , $T_C=25^\circ\text{C}$	$I_{D, pulse}$	60	A
Continuous diode forward current <sup>1)</sup> , $T_C=25^\circ\text{C}$	$I_S$	20	A
Diode pulsed current <sup>2)</sup> , $T_C=25^\circ\text{C}$	$I_{S, pulse}$	60	A
Power dissipation <sup>3)</sup> , $T_C=25^\circ\text{C}$	$P_D$	151	W
Single pulsed avalanche energy <sup>5)</sup>	$E_{AS}$	176	mJ
MOSFET dv/dt ruggedness, $V_{DS}=0\dots 480\text{ V}$	dv/dt	50	V/ns
Reverse diode dv/dt, $V_{DS}=0\dots 480\text{ V}$ , $I_{SD}\leq I_D$	dv/dt	50	V/ns
Operation and storage temperature	$T_{stg}, T_j$	-55 to 150	$^\circ\text{C}$

**Thermal Characteristics**

Parameter	Symbol	Value	Unit
Thermal resistance, junction-case	$R_{\theta JC}$	0.83	$^\circ\text{C/W}$
Thermal resistance, junction-ambient <sup>4)</sup>	$R_{\theta JA}$	62	$^\circ\text{C/W}$

**Electrical Characteristics** at  $T_j=25^\circ\text{C}$  unless otherwise specified

Parameter	Symbol	Min.	Typ.	Max.	Unit	Test condition
Drain-source breakdown voltage	$BV_{DSS}$	600			V	$V_{GS}=0\text{ V}$ , $I_D=250\ \mu\text{A}$
		650				$V_{GS}=0\text{ V}$ , $I_D=250\ \mu\text{A}$ , $T_j=150^\circ\text{C}$
Gate threshold voltage	$V_{GS(th)}$	3.0		4.5	V	$V_{DS}=V_{GS}$ , $I_D=250\ \mu\text{A}$
Drain-source on-state resistance	$R_{DS(ON)}$		0.16	0.20	$\Omega$	$V_{GS}=10\text{ V}$ , $I_D=10\text{ A}$
			0.37			$V_{GS}=10\text{ V}$ , $I_D=10\text{ A}$ , $T_j=150^\circ\text{C}$
Gate-source leakage current	$I_{GSS}$			100	nA	$V_{GS}=30\text{ V}$
				-100		$V_{GS}=-30\text{ V}$
Drain-source leakage current	$I_{DSS}$			10	$\mu\text{A}$	$V_{DS}=600\text{ V}$ , $V_{GS}=0\text{ V}$
Gate resistance	$R_G$		17.4		$\Omega$	$f=1\text{ MHz}$ , Open drain

### Dynamic Characteristics

Parameter	Symbol	Min.	Typ.	Max.	Unit	Test condition
Input capacitance	$C_{iss}$		1920		pF	$V_{GS}=0\text{ V}$ , $V_{DS}=50\text{ V}$ , $f=100\text{ kHz}$
Output capacitance	$C_{oss}$		98.6		pF	
Reverse transfer capacitance	$C_{rss}$		2.3		pF	
Turn-on delay time	$t_{d(on)}$		41.9		ns	$V_{GS}=10\text{ V}$ , $V_{DS}=400\text{ V}$ , $R_G=2\ \Omega$ , $I_D=10\text{ A}$
Rise time	$t_r$		68.2		ns	
Turn-off delay time	$t_{d(off)}$		77.7		ns	
Fall time	$t_f$		33.9		ns	

### Gate Charge Characteristics

Parameter	Symbol	Min.	Typ.	Max.	Unit	Test condition
Total gate charge	$Q_g$		72.9		nC	$V_{GS}=10\text{ V}$ , $V_{DS}=400\text{ V}$ , $I_D=10\text{ A}$
Gate-source charge	$Q_{gs}$		17.2		nC	
Gate-drain charge	$Q_{gd}$		14		nC	
Gate plateau voltage	$V_{plateau}$		6.5		V	

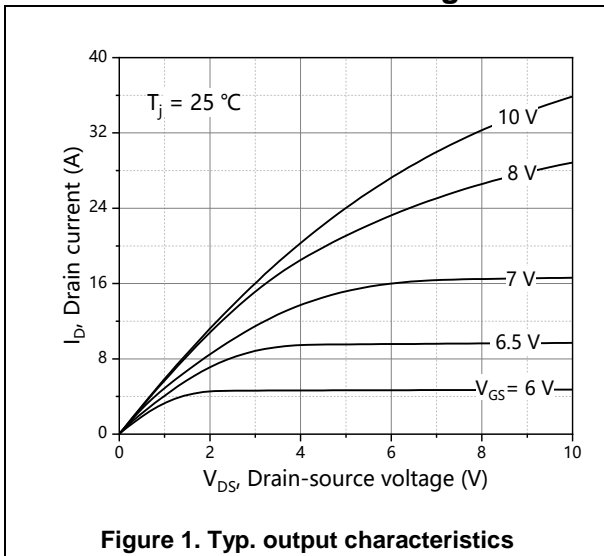
### Body Diode Characteristics

Parameter	Symbol	Min.	Typ.	Max.	Unit	Test condition
Diode forward voltage	$V_{SD}$			1.3	V	$I_S=20\text{ A}$ , $V_{GS}=0\text{ V}$
Reverse recovery time	$t_{rr}$		132		ns	$V_R=400\text{ V}$ , $I_S=10\text{ A}$ , $di/dt=100\text{ A}/\mu\text{s}$
Reverse recovery charge	$Q_{rr}$		730		nC	
Peak reverse recovery current	$I_{rrm}$		10.8		A	

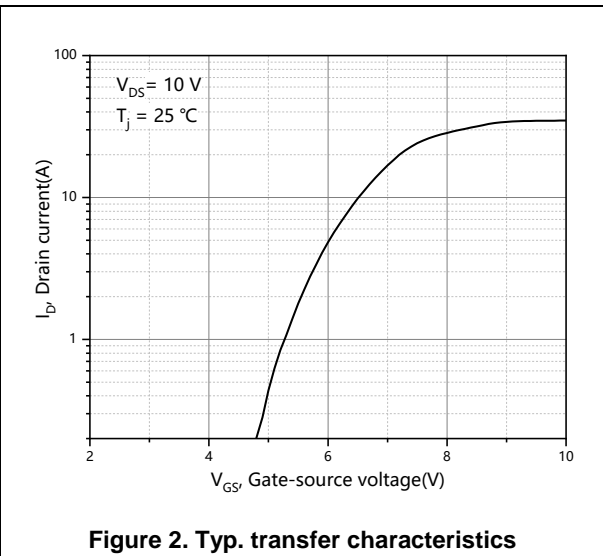
### Note

- 1) Calculated continuous current based on maximum allowable junction temperature.
- 2) Repetitive rating; pulse width limited by max. junction temperature.
- 3)  $P_d$  is based on max. junction temperature, using junction-case thermal resistance.
- 4) The value of  $R_{\theta JA}$  is measured with the device mounted on 1 in 2 FR-4 board with 2oz. Copper, in a still air environment with  $T_a=25\text{ }^\circ\text{C}$ .
- 5)  $V_{DD}=100\text{ V}$ ,  $V_{GS}=10\text{ V}$ ,  $L=79.9\text{ mH}$ , starting  $T_j=25\text{ }^\circ\text{C}$ .

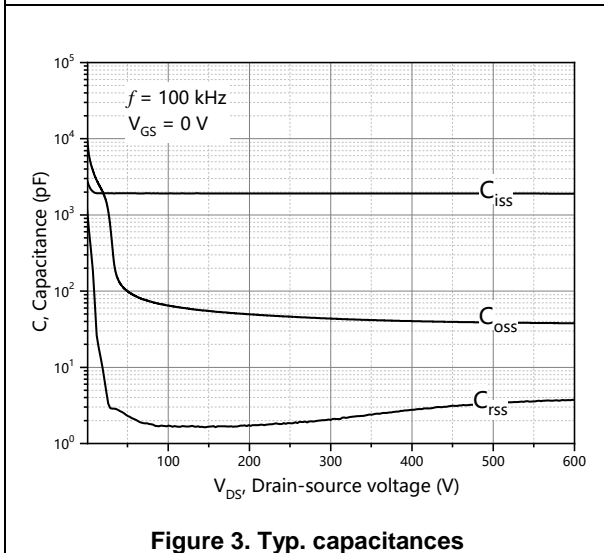
**Electrical Characteristics Diagrams**



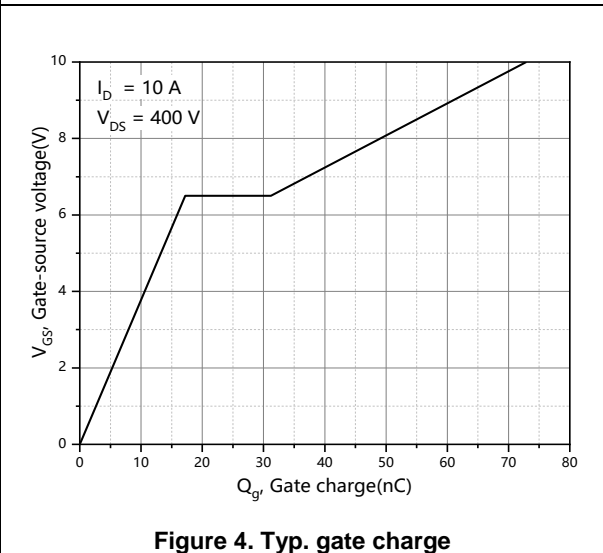
**Figure 1. Typ. output characteristics**



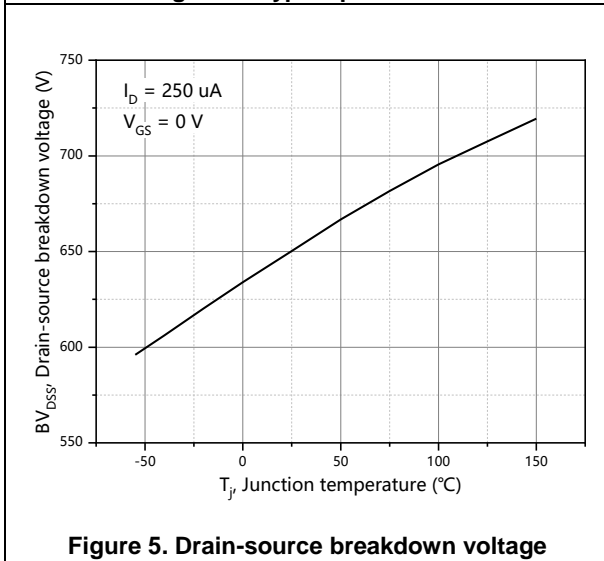
**Figure 2. Typ. transfer characteristics**



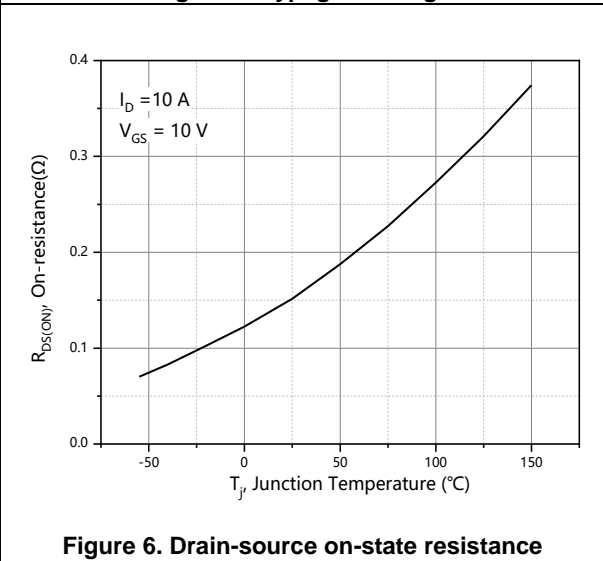
**Figure 3. Typ. capacitances**



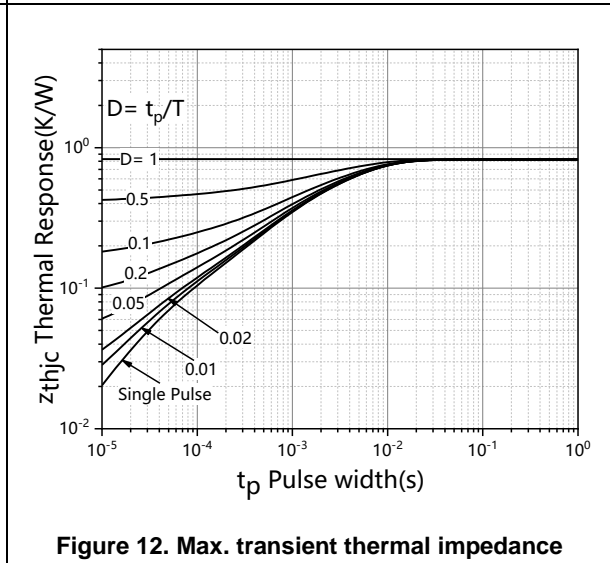
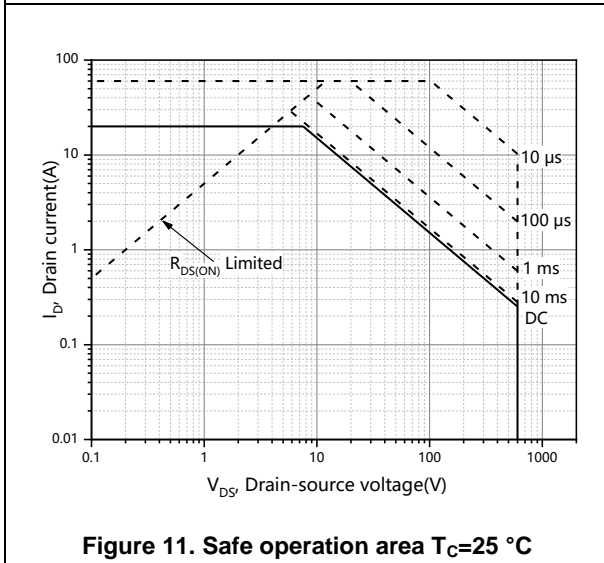
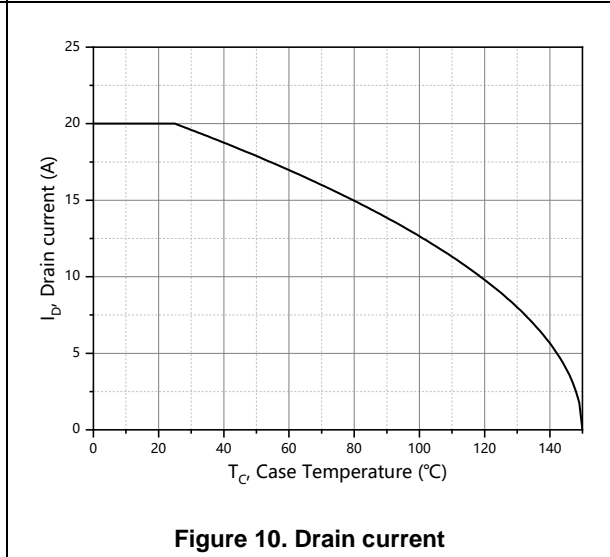
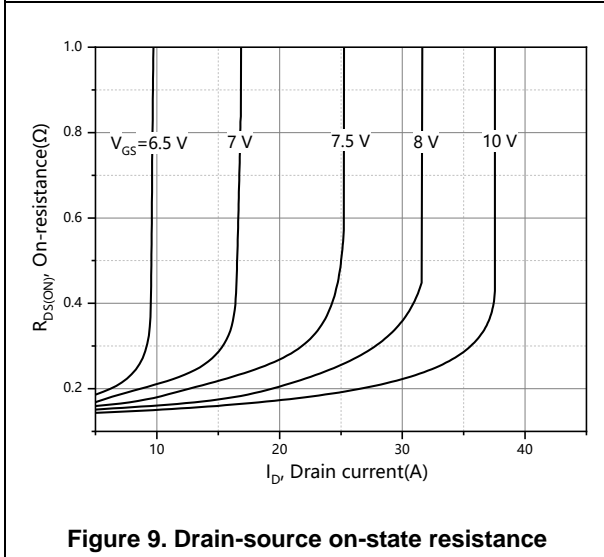
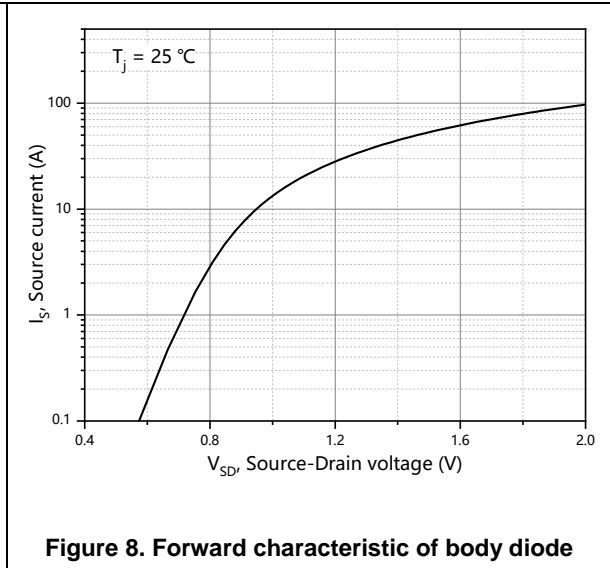
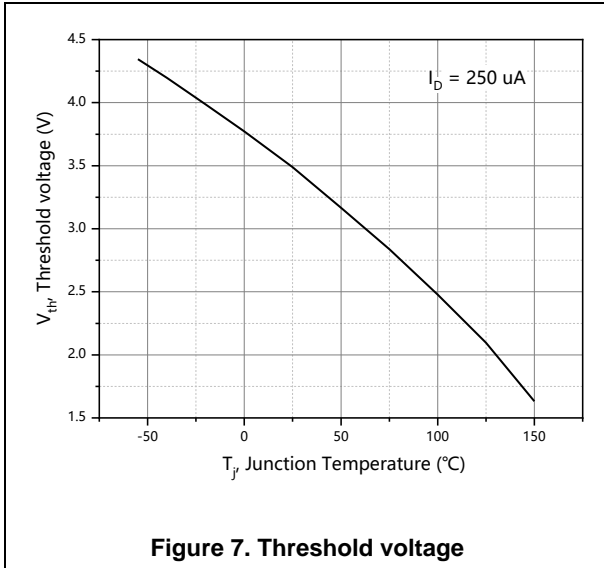
**Figure 4. Typ. gate charge**



**Figure 5. Drain-source breakdown voltage**



**Figure 6. Drain-source on-state resistance**



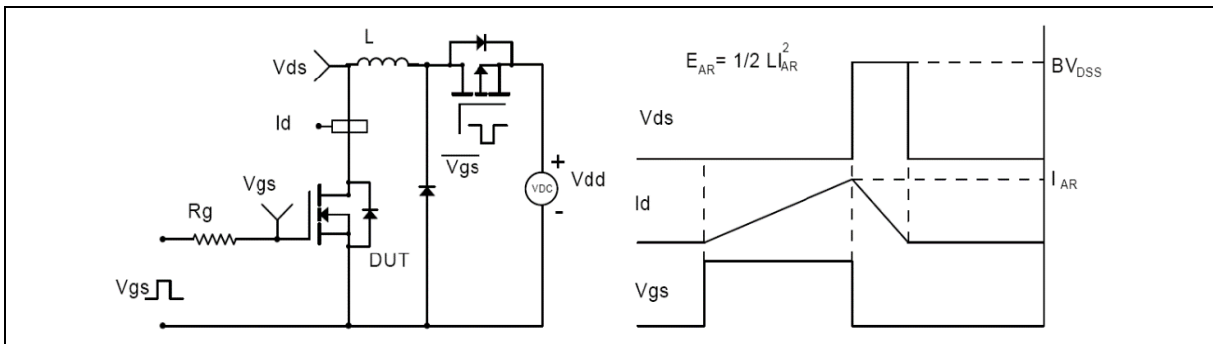
**Test circuits and waveforms**



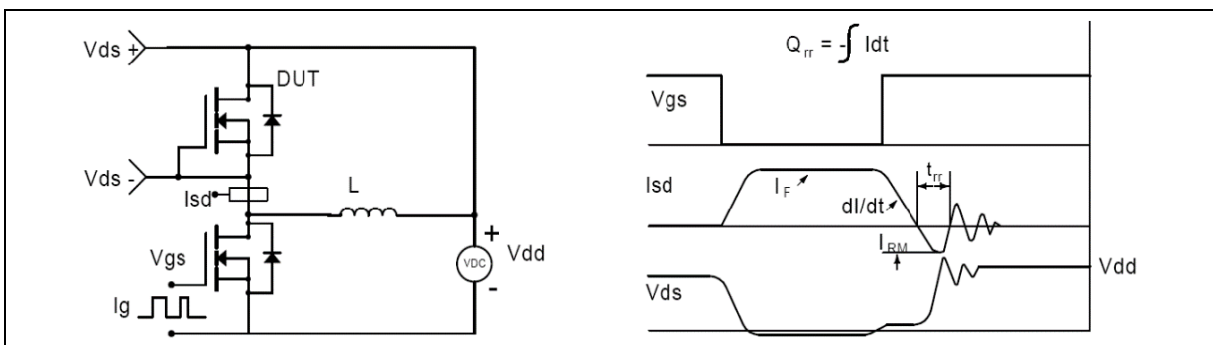
**Figure 1. Gate charge test circuit & waveform**



**Figure 2. Switching time test circuit & waveforms**

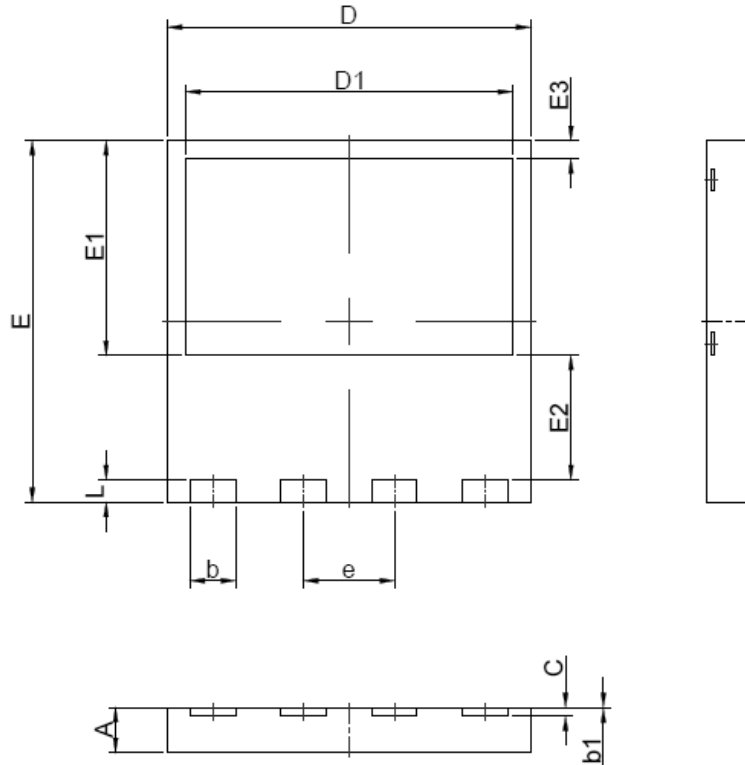


**Figure 3. Unclamped inductive switching (UIS) test circuit & waveforms**



**Figure 4. Diode reverse recovery test circuit & waveforms**

**Package Information**



Symbol	mm		
	Min	Nom	Max
A	0.90	1.00	1.10
b	0.90	1.00	1.10
b1	0.00	0.02	0.05
C	0.2 REF		
D	7.90	8.00	8.10
D1	7.10	7.20	7.30
E	7.90	8.00	8.10
E1	4.65	4.75	4.85
E2	2.65	2.75	2.85
E3	0.3	0.4	0.5
e	2.0 BSC		
L	0.4	0.5	0.6

Version 1: PDFN8\*8-L package outline dimension

### Ordering Information

Package Type	Units/ Reel	Reels/ Inner Box	Units/ Inner Box	Inner Boxes/ Carton Box	Units/ Carton Box
PDFN8*8-L	2500	1	2500	10	25000

### Product Information

Product	Package	Pb Free	RoHS	Halogen Free
OSG60R200JSZF	PDFN8*8	yes	yes	yes

### Legal Disclaimer

The information given in this document shall in no event be regarded as a guarantee of conditions or characteristics. With respect to any examples or hints given herein, any typical values stated herein and/or any information regarding the application of the device, Oriental Semiconductor hereby disclaims any and all warranties and liabilities of any kind, including without limitation, warranties of non-infringement of intellectual property rights of any third party.

For further information on technology, delivery terms and conditions and prices, please contact the Oriental Semiconductor sales representatives ([www.orientalsemi.com](http://www.orientalsemi.com)).

© Oriental Semiconductor Co.,Ltd. All Rights Reserved /