

General Description

The GreenMOS[®] high voltage MOSFET utilizes charge balance technology to achieve outstanding low on-resistance and lower gate charge. It is engineered to minimize conduction loss, provide superior switching performance and robust avalanche capability.

The GreenMOS[®] Generic series is optimized for extreme switching performance to minimize switching loss. It is tailored for high power density applications to meet the highest efficiency standards.

Features

- Low $R_{DS(ON)}$ & FOM
- Extremely low switching loss
- Excellent stability and uniformity



Applications

- PC power
- LED lighting
- Telecom power
- Server power
- EV Charger
- Solar/UPS

Key Performance Parameters

| Parameter | Value | Unit |
|--------------------------------|-------|----------|
| $V_{DS, min} @ T_{j(max)}$ | 750 | V |
| $I_D, pulse$ | 15 | A |
| $R_{DS(ON)}, max @ V_{GS}=10V$ | 1 | Ω |
| Q_g | 7.3 | nC |

Marking Information

| Product Name | Package | Marking |
|--------------|---------|-----------|
| OSG70R1KAF | TO251 | OSG70R1KA |

Package & Pin Information

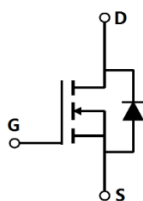

Absolute Maximum Ratings at $T_j=25^{\circ}\text{C}$ unless otherwise noted

| Parameter | Symbol | Value | Unit |
|---|----------------|------------|--------------------|
| Drain-source voltage | V_{DS} | 700 | V |
| Gate-source voltage | V_{GS} | ± 30 | V |
| Continuous drain current ¹⁾ , $T_C=25^{\circ}\text{C}$ | I_D | 5 | A |
| Continuous drain current ¹⁾ , $T_C=100^{\circ}\text{C}$ | | 3.2 | |
| Pulsed drain current ²⁾ , $T_C=25^{\circ}\text{C}$ | $I_{D, pulse}$ | 15 | A |
| Continuous diode forward current ¹⁾ , $T_C=25^{\circ}\text{C}$ | I_S | 5 | A |
| Diode pulsed current ²⁾ , $T_C=25^{\circ}\text{C}$ | $I_{S, pulse}$ | 15 | A |
| Power dissipation ³⁾ , $T_C=25^{\circ}\text{C}$ | P_D | 37 | W |
| Single pulsed avalanche energy ⁵⁾ | E_{AS} | 160 | mJ |
| MOSFET dv/dt ruggedness, $V_{DS}=0\dots 480\text{ V}$ | dv/dt | 50 | V/ns |
| Reverse diode dv/dt, $V_{DS}=0\dots 480\text{ V}$, $I_{SD}\leq I_D$ | dv/dt | 15 | V/ns |
| Operation and storage temperature | T_{stg}, T_j | -55 to 150 | $^{\circ}\text{C}$ |

Thermal Characteristics

| Parameter | Symbol | Value | Unit |
|--|-----------------|-------|----------------------|
| Thermal resistance, junction-case | $R_{\theta JC}$ | 3.4 | $^{\circ}\text{C/W}$ |
| Thermal resistance, junction-ambient ⁴⁾ | $R_{\theta JA}$ | 62 | $^{\circ}\text{C/W}$ |

Electrical Characteristics at $T_j=25^{\circ}\text{C}$ unless otherwise specified

| Parameter | Symbol | Min. | Typ. | Max. | Unit | Test condition |
|----------------------------------|--------------|------|------|------|---------------|--|
| Drain-source breakdown voltage | BV_{DSS} | 700 | | | V | $V_{GS}=0\text{ V}$, $I_D=250\ \mu\text{A}$ |
| | | 750 | 810 | | | $V_{GS}=0\text{ V}$, $I_D=250\ \mu\text{A}$, $T_j=150^{\circ}\text{C}$ |
| Gate threshold voltage | $V_{GS(th)}$ | 2.0 | | 4.0 | V | $V_{DS}=V_{GS}$, $I_D=250\ \mu\text{A}$ |
| Drain-source on-state resistance | $R_{DS(on)}$ | | 0.8 | 1.0 | Ω | $V_{GS}=10\text{ V}$, $I_D=2.5\text{ A}$ |
| | | | 2.0 | | | $V_{GS}=10\text{ V}$, $I_D=2.5\text{ A}$, $T_j=150^{\circ}\text{C}$ |
| Gate-source leakage current | I_{GSS} | | | 100 | nA | $V_{GS}=30\text{ V}$ |
| | | | | -100 | | $V_{GS}=-30\text{ V}$ |
| Drain-source leakage current | I_{DSS} | | | 1 | μA | $V_{DS}=700\text{ V}$, $V_{GS}=0\text{ V}$ |

Dynamic Characteristics

| Parameter | Symbol | Min. | Typ. | Max. | Unit | Test condition |
|------------------------------|--------------|------|-------|------|------|---|
| Input capacitance | C_{iss} | | 363.6 | | pF | $V_{GS}=0\text{ V}$, $V_{DS}=50\text{ V}$, $f=1\text{ MHz}$ |
| Output capacitance | C_{oss} | | 26.6 | | pF | |
| Reverse transfer capacitance | C_{rss} | | 1.1 | | pF | |
| Turn-on delay time | $t_{d(on)}$ | | 14.5 | | ns | $V_{GS}=10\text{ V}$, $V_{DS}=400\text{ V}$, $R_G=25\ \Omega$, $I_D=3\text{ A}$ |
| Rise time | t_r | | 6.8 | | ns | |
| Turn-off delay time | $t_{d(off)}$ | | 24.4 | | ns | |
| Fall time | t_f | | 7.5 | | ns | |

Gate Charge Characteristics

| Parameter | Symbol | Min. | Typ. | Max. | Unit | Test condition |
|----------------------|---------------|------|------|------|------|---|
| Total gate charge | Q_g | | 7.3 | | nC | $V_{GS}=10\text{ V}$, $V_{DS}=400\text{ V}$, $I_D=3\text{ A}$ |
| Gate-source charge | Q_{gs} | | 1.9 | | nC | |
| Gate-drain charge | Q_{gd} | | 3 | | nC | |
| Gate plateau voltage | $V_{plateau}$ | | 5.6 | | V | |

Body Diode Characteristics

| Parameter | Symbol | Min. | Typ. | Max. | Unit | Test condition |
|-------------------------------|-----------|------|-------|------|---------------|--|
| Diode forward voltage | V_{SD} | | | 1.3 | V | $I_S=5\text{ A}$, $V_{GS}=0\text{ V}$ |
| Reverse recovery time | t_{rr} | | 175.7 | | ns | $V_R=400\text{ V}$, $I_S=5\text{ A}$, $di/dt=100\text{ A}/\mu\text{s}$ |
| Reverse recovery charge | Q_{rr} | | 1.3 | | μC | |
| Peak reverse recovery current | I_{rrm} | | 12.6 | | A | |

Note

- 1) Calculated continuous current based on maximum allowable junction temperature.
- 2) Repetitive rating; pulse width limited by max. junction temperature.
- 3) P_d is based on max. junction temperature, using junction-case thermal resistance.
- 4) The value of $R_{\theta JA}$ is measured with the device mounted on 1 in 2 FR-4 board with 2oz. Copper, in a still air environment with $T_a=25\text{ }^\circ\text{C}$.
- 5) $V_{DD}=50\text{ V}$, $V_{GS}=10\text{ V}$, $L=20\text{ mH}$, starting $T_j=25\text{ }^\circ\text{C}$.

Electrical Characteristics Diagrams

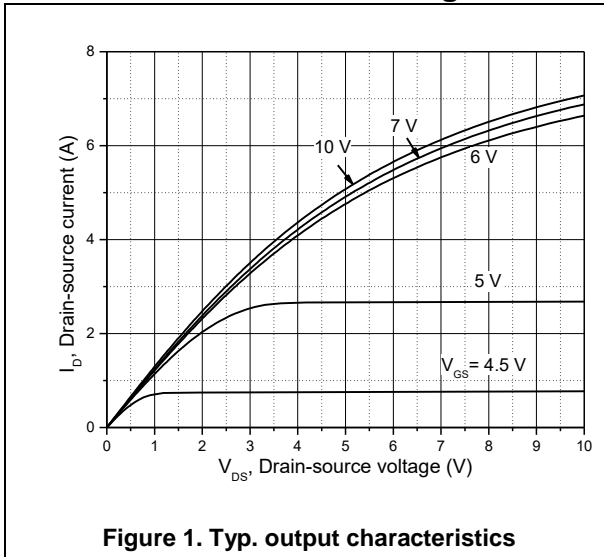

Figure 1. Typ. output characteristics

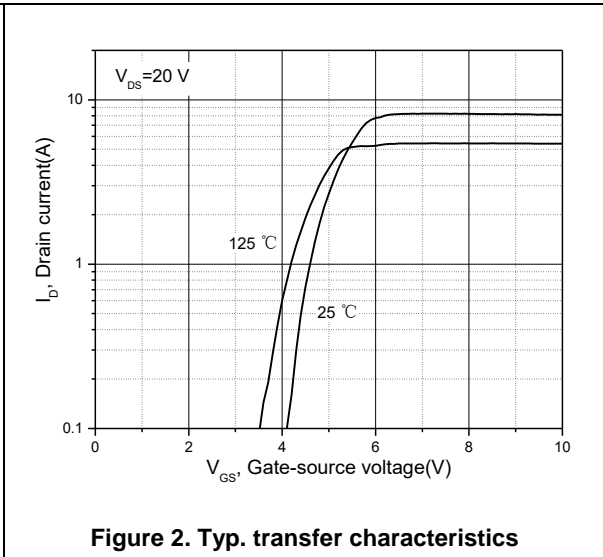

Figure 2. Typ. transfer characteristics

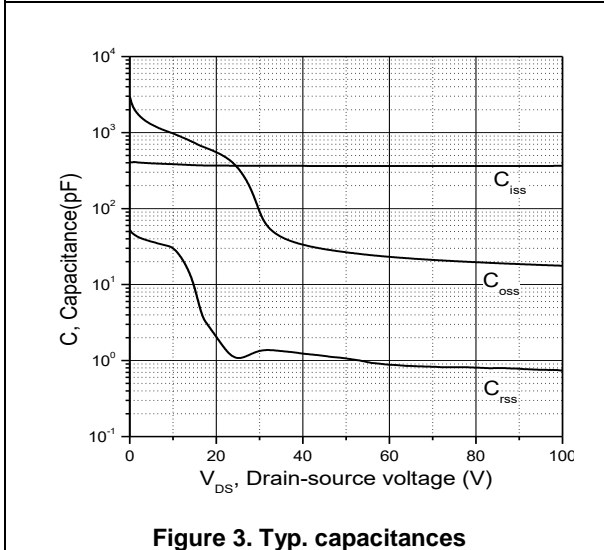

Figure 3. Typ. capacitances

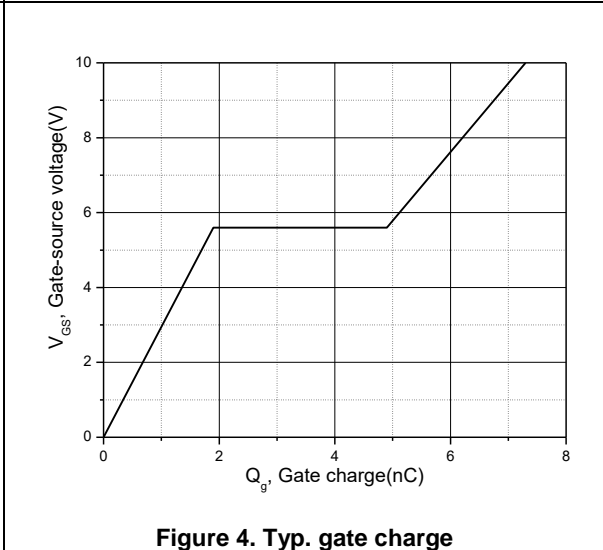

Figure 4. Typ. gate charge

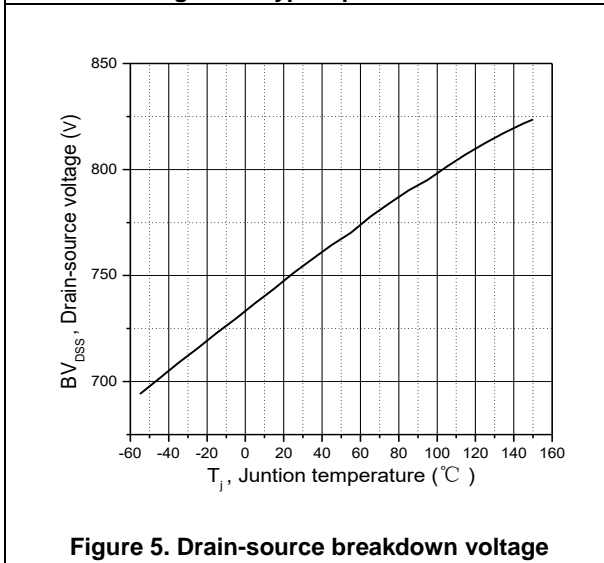

Figure 5. Drain-source breakdown voltage

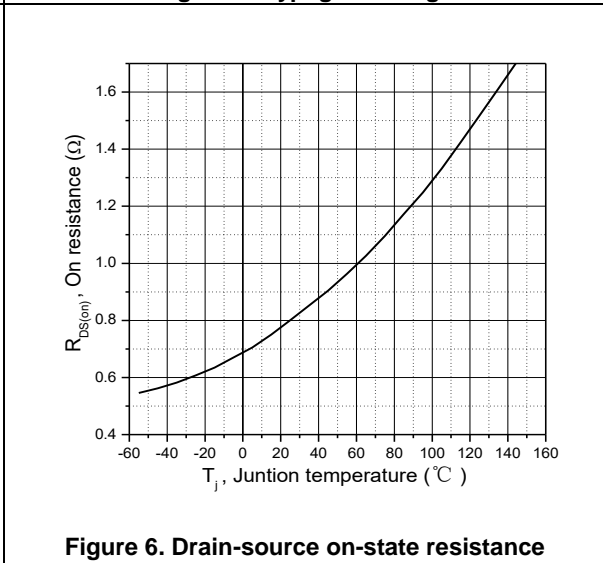

Figure 6. Drain-source on-state resistance

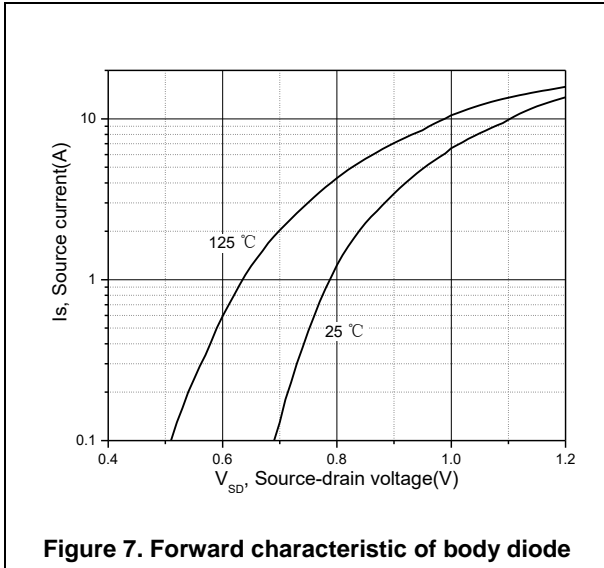

Figure 7. Forward characteristic of body diode

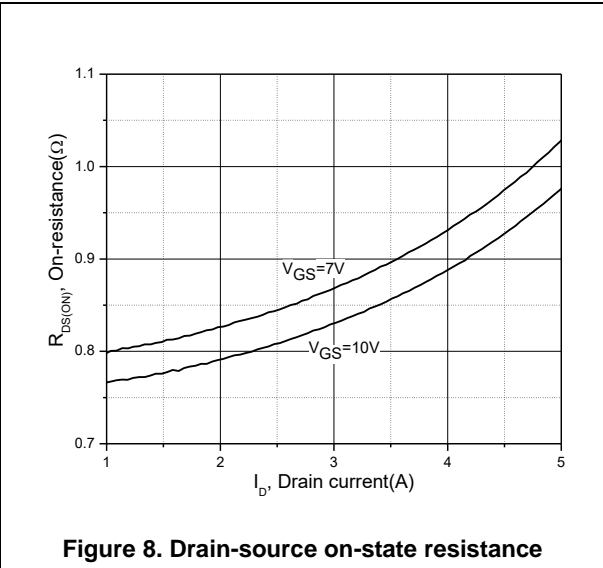

Figure 8. Drain-source on-state resistance

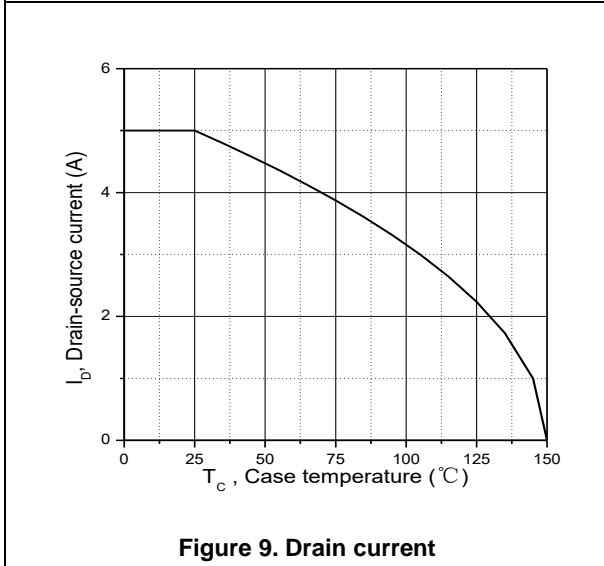

Figure 9. Drain current

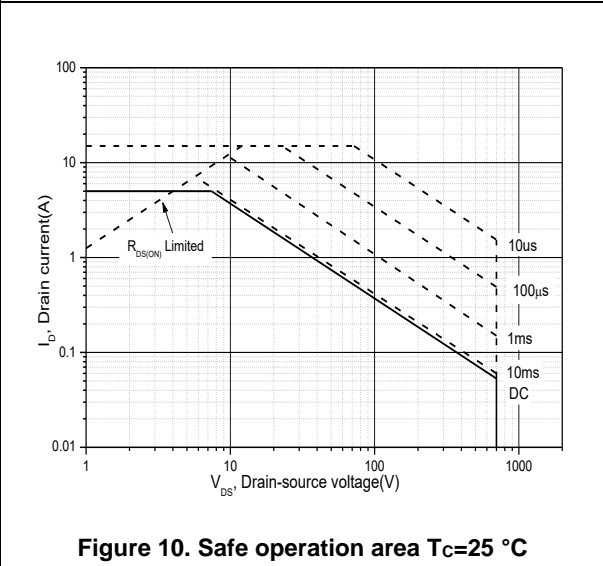

Figure 10. Safe operation area Tc=25 °C

Test circuits and waveforms



Figure 1. Gate charge test circuit & waveform



Figure 2. Switching time test circuit & waveforms

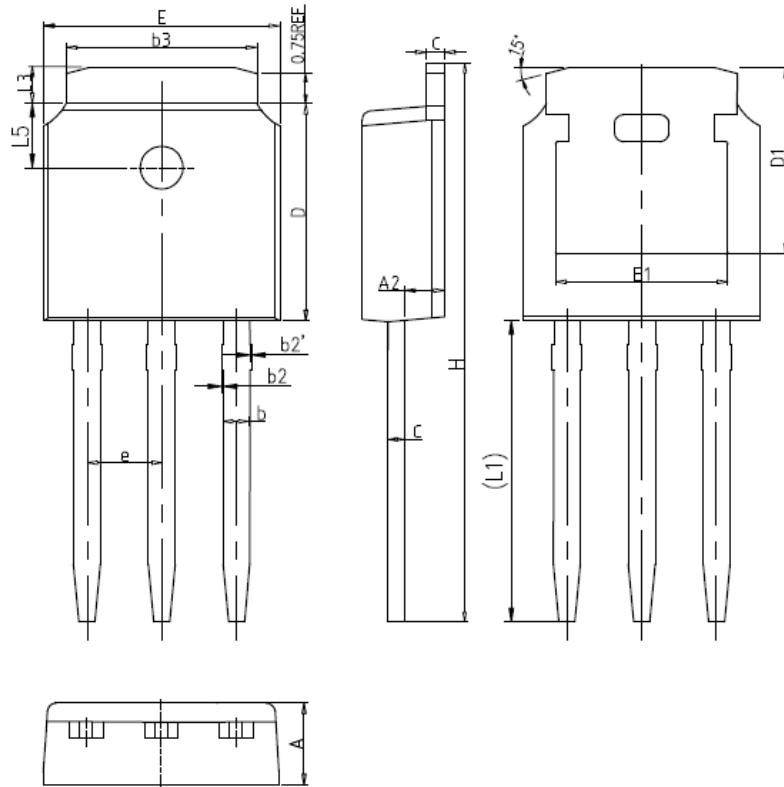

Figure 3. Unclamped inductive switching (UIS) test circuit & waveforms



Figure 4. Diode reverse recovery test circuit & waveforms

Package Information



| Symbol | mm | | |
|--------|----------|-------|-------|
| | Min | Nom | Max |
| A | 2.20 | 2.30 | 2.40 |
| A2 | 0.97 | 1.07 | 1.17 |
| b | 0.68 | 0.78 | 0.90 |
| b2 | 0.00 | 0.04 | 0.10 |
| b2' | 0.00 | 0.04 | 0.10 |
| b3 | 5.20 | 5.33 | 5.50 |
| c | 0.43 | 0.53 | 0.63 |
| D | 5.98 | 6.10 | 6.22 |
| D1 | 5.30REF | | |
| E | 6.40 | 6.60 | 6.80 |
| E1 | 4.63 | - | - |
| e | 2.286BSC | | |
| H | 16.22 | 16.52 | 16.82 |
| L1 | 9.15 | 9.40 | 9.65 |
| L3 | 0.88 | 1.02 | 1.28 |
| L5 | 1.65 | 1.80 | 1.95 |

Version 1: TO251-C package outline dimension

Ordering Information

| Package Type | Units/ Tube | Tubes/ Inner Box | Units/ Inner Box | Inner Boxes/ Carton Box | Units/ Carton Box |
|--------------|-------------|------------------|------------------|-------------------------|-------------------|
| TO251-C | 75 | 66 | 4950 | 6 | 29700 |

Product Information

| Product | Package | Pb Free | RoHS | Halogen Free |
|------------|---------|---------|------|--------------|
| OSG70R1KAF | TO251 | yes | yes | yes |

Legal Disclaimer

The information given in this document shall in no event be regarded as a guarantee of conditions or characteristics. With respect to any examples or hints given herein, any typical values stated herein and/or any information regarding the application of the device, Oriental Semiconductor hereby disclaims any and all warranties and liabilities of any kind, including without limitation, warranties of non-infringement of intellectual property rights of any third party.

For further information on technology, delivery terms and conditions and prices, please contact the Oriental Semiconductor sales representatives (www.orientalsemi.com).

© Oriental Semiconductor Co.,Ltd. All Rights Reserved 