

General Description

The GreenMOS[®] high voltage MOSFET utilizes charge balance technology to achieve outstanding low on-resistance and lower gate charge. It is engineered to minimize conduction loss, provide superior switching performance and robust avalanche capability.

The GreenMOS[®] Generic series is optimized for extreme switching performance to minimize switching loss. It is tailored for high power density applications to meet the highest efficiency standards.

Features

- Low $R_{DS(ON)}$ & FOM
- Extremely low switching loss
- Excellent stability and uniformity

GreenMOS[®]



Applications

- PC power
- LED lighting
- Telecom power
- Server power
- EV Charger
- Solar/UPS

Key Performance Parameters

Parameter	Value	Unit
$V_{DS, min} @ T_{j(max)}$	750	V
$I_D, pulse$	6	A
$R_{DS(ON)}, max @ V_{GS}=10V$	2.6	Ω
Q_g	7.9	nC

Marking Information

Product Name	Package	Marking
OSG70R2K6PF	TO220	OSG70R2K6P

Package & Pin Information

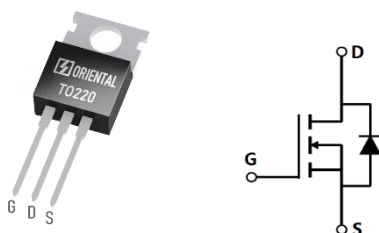

Absolute Maximum Ratings at $T_j=25^{\circ}\text{C}$ unless otherwise noted

Parameter	Symbol	Value	Unit
Drain-source voltage	V_{DS}	700	V
Gate-source voltage	V_{GS}	± 30	V
Continuous drain current ¹⁾ , $T_C=25^{\circ}\text{C}$	I_D	2	A
Continuous drain current ¹⁾ , $T_C=100^{\circ}\text{C}$		1.3	
Pulsed drain current ²⁾ , $T_C=25^{\circ}\text{C}$	$I_{D, pulse}$	6	A
Continuous diode forward current ¹⁾ , $T_C=25^{\circ}\text{C}$	I_S	2	A
Diode pulsed current ²⁾ , $T_C=25^{\circ}\text{C}$	$I_{S, pulse}$	6	A
Power dissipation ³⁾ , $T_C=25^{\circ}\text{C}$	P_D	22.3	W
Single pulsed avalanche energy ⁵⁾	E_{AS}	70	mJ
MOSFET dv/dt ruggedness, $V_{DS}=0\dots 480\text{ V}$	dv/dt	50	V/ns
Reverse diode dv/dt, $V_{DS}=0\dots 480\text{ V}$, $I_{SD}\leq I_D$	dv/dt	15	V/ns
Operation and storage temperature	T_{stg}, T_j	-55 to 150	$^{\circ}\text{C}$

Thermal Characteristics

Parameter	Symbol	Value	Unit
Thermal resistance, junction-case	$R_{\theta JC}$	5.6	$^{\circ}\text{C/W}$
Thermal resistance, junction-ambient ⁴⁾	$R_{\theta JA}$	62	$^{\circ}\text{C/W}$

Electrical Characteristics at $T_j=25^{\circ}\text{C}$ unless otherwise specified

Parameter	Symbol	Min.	Typ.	Max.	Unit	Test condition
Drain-source breakdown voltage	BV_{DSS}	700			V	$V_{GS}=0\text{ V}$, $I_D=250\ \mu\text{A}$
		750	810			$V_{GS}=0\text{ V}$, $I_D=250\ \mu\text{A}$, $T_j=150^{\circ}\text{C}$
Gate threshold voltage	$V_{GS(th)}$	2.0		4.0	V	$V_{DS}=V_{GS}$, $I_D=250\ \mu\text{A}$
Drain-source on-state resistance	$R_{DS(on)}$		2.3	2.6	Ω	$V_{GS}=10\text{ V}$, $I_D=1\text{ A}$
			5.3			$V_{GS}=10\text{ V}$, $I_D=1\text{ A}$, $T_j=150^{\circ}\text{C}$
Gate-source leakage current	I_{GSS}			100	nA	$V_{GS}=30\text{ V}$
				-100		$V_{GS}=-30\text{ V}$
Drain-source leakage current	I_{DSS}			1	μA	$V_{DS}=700\text{ V}$, $V_{GS}=0\text{ V}$

Dynamic Characteristics

Parameter	Symbol	Min.	Typ.	Max.	Unit	Test condition
Input capacitance	C_{iss}		182		pF	$V_{GS}=0\text{ V}$, $V_{DS}=50\text{ V}$, $f=1\text{ MHz}$
Output capacitance	C_{oss}		12.08		pF	
Reverse transfer capacitance	C_{rss}		0.75		pF	
Turn-on delay time	$t_{d(on)}$		20.5		ns	$V_{GS}=10\text{ V}$, $V_{DS}=350\text{ V}$, $R_G=25\ \Omega$, $I_D=1\text{ A}$
Rise time	t_r		11.2		ns	
Turn-off delay time	$t_{d(off)}$		49.6		ns	
Fall time	t_f		40.4		ns	

Gate Charge Characteristics

Parameter	Symbol	Min.	Typ.	Max.	Unit	Test condition
Total gate charge	Q_g		7.9		nC	$V_{GS}=10\text{ V}$, $V_{DS}=560\text{ V}$, $I_D=2\text{ A}$
Gate-source charge	Q_{gs}		1.3		nC	
Gate-drain charge	Q_{gd}		4.1		nC	
Gate plateau voltage	$V_{plateau}$		5.4		V	

Body Diode Characteristics

Parameter	Symbol	Min.	Typ.	Max.	Unit	Test condition
Diode forward voltage	V_{SD}			1.3	V	$I_S=2\text{ A}$, $V_{GS}=0\text{ V}$
Reverse recovery time	t_{rr}		143		ns	$V_R=350\text{ V}$, $I_S=2\text{ A}$, $di/dt=100\text{ A}/\mu\text{s}$
Reverse recovery charge	Q_{rr}		0.222		μC	
Peak reverse recovery current	I_{rrm}		8.9		A	

Note

- 1) Calculated continuous current based on maximum allowable junction temperature.
- 2) Repetitive rating; pulse width limited by max. junction temperature.
- 3) P_d is based on max. junction temperature, using junction-case thermal resistance.
- 4) The value of $R_{\theta JA}$ is measured with the device mounted on 1 in 2 FR-4 board with 2oz. Copper, in a still air environment with $T_a=25\text{ }^\circ\text{C}$.
- 5) $V_{DD}=50\text{ V}$, $V_{GS}=10\text{ V}$, $L=22.5\text{ mH}$, starting $T_j=25\text{ }^\circ\text{C}$.

Electrical Characteristics Diagrams

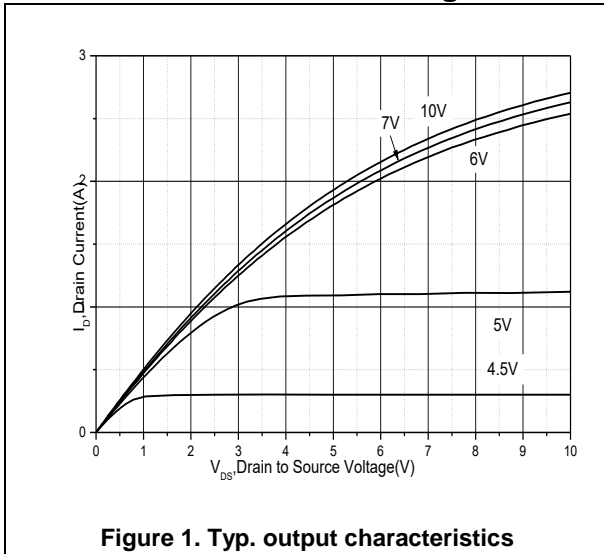

Figure 1. Typ. output characteristics

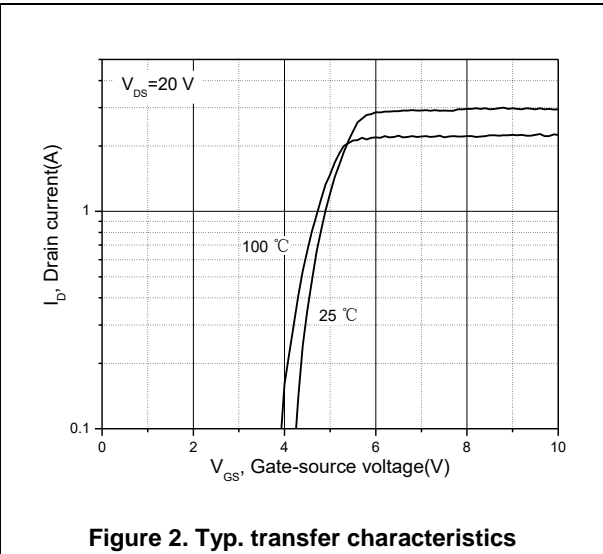

Figure 2. Typ. transfer characteristics

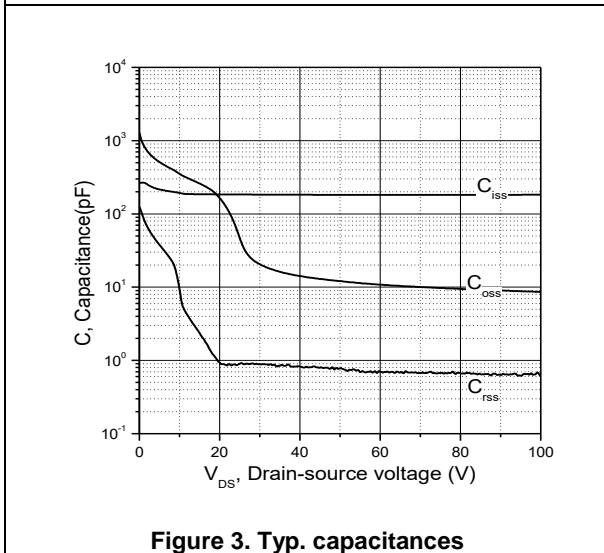

Figure 3. Typ. capacitances

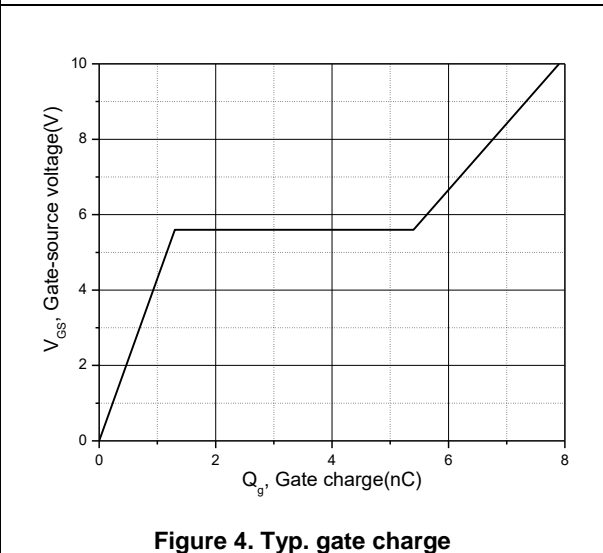

Figure 4. Typ. gate charge

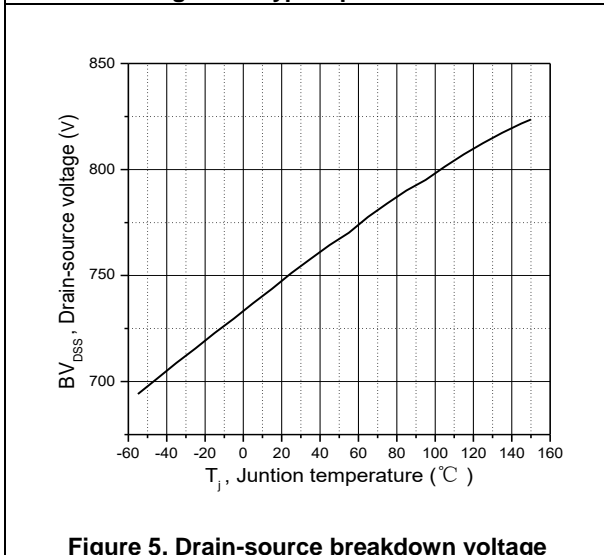

Figure 5. Drain-source breakdown voltage

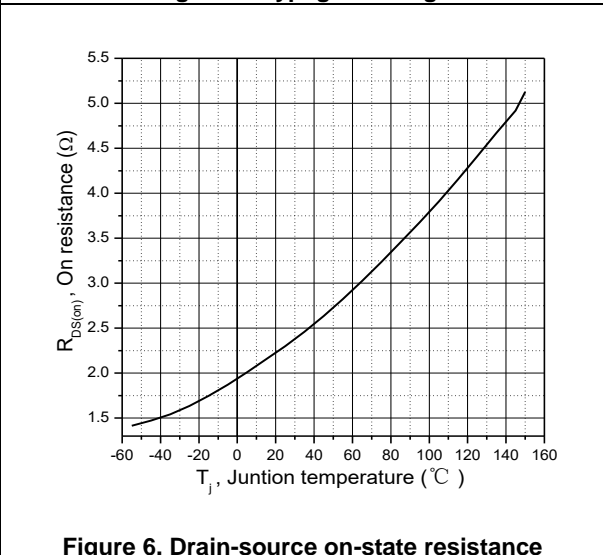
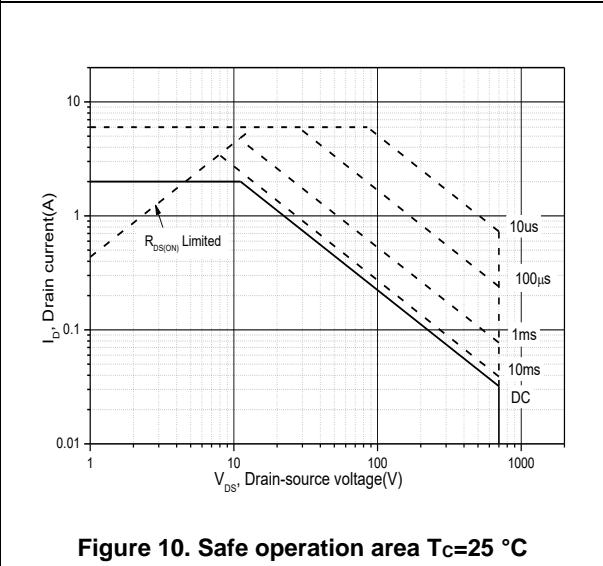
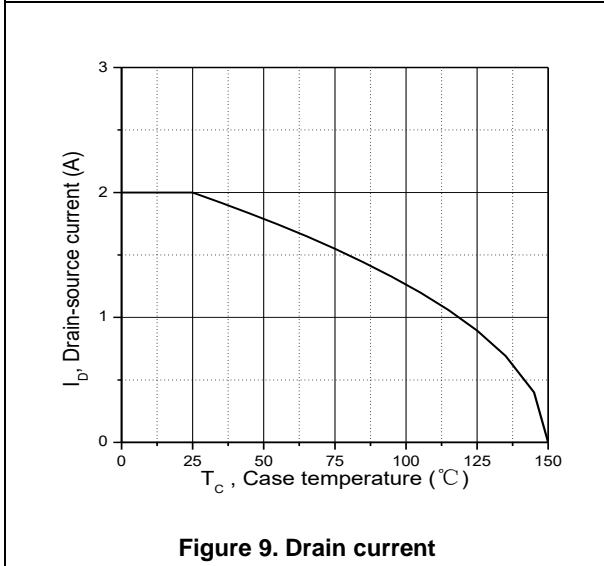
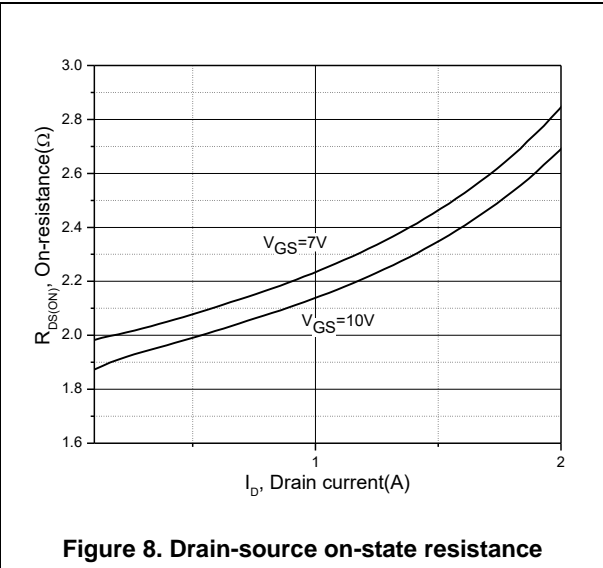
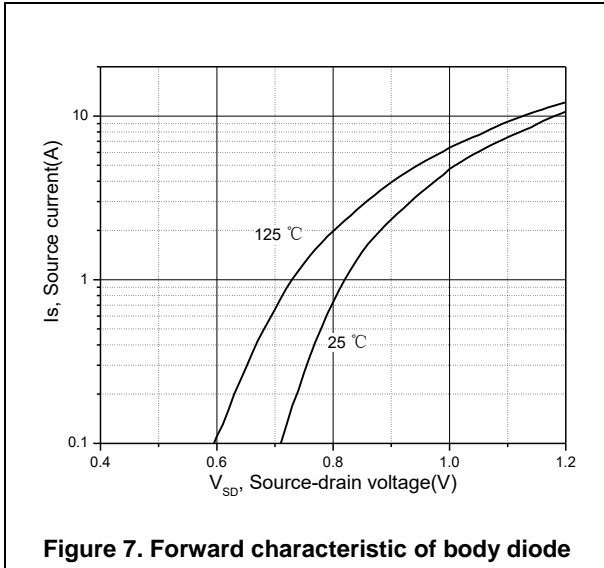

Figure 6. Drain-source on-state resistance



Test circuits and waveforms

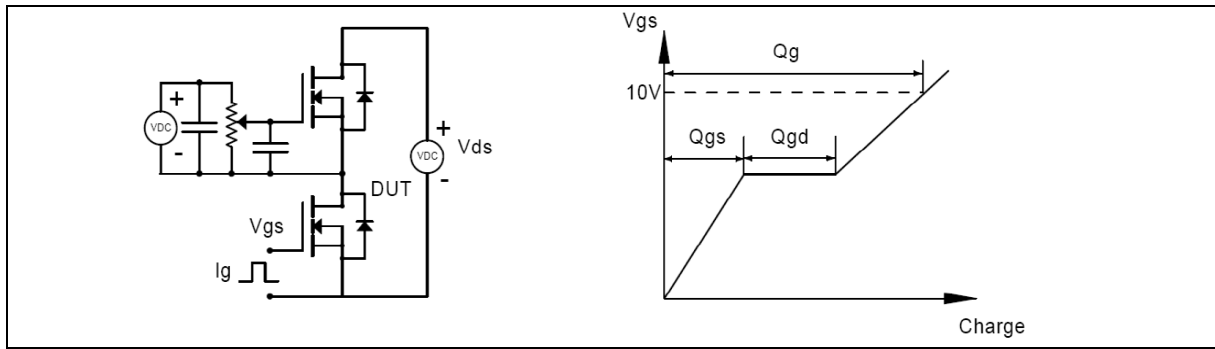

Figure 1. Gate charge test circuit & waveform

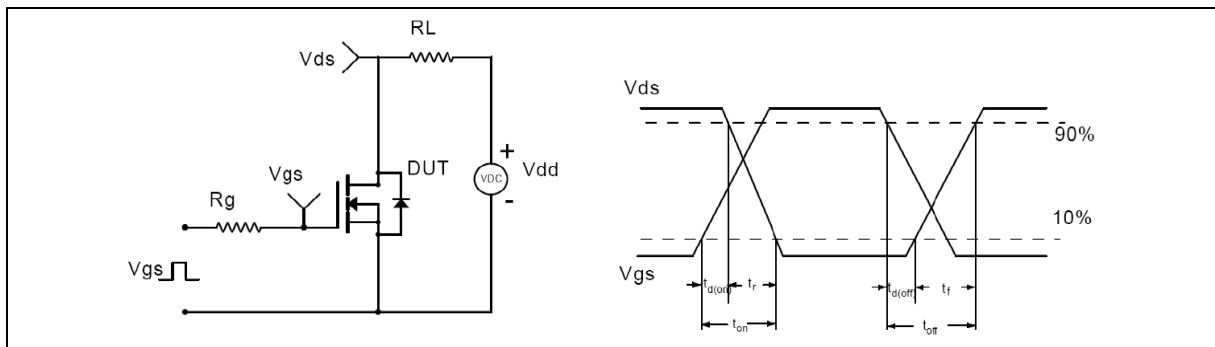

Figure 2. Switching time test circuit & waveforms

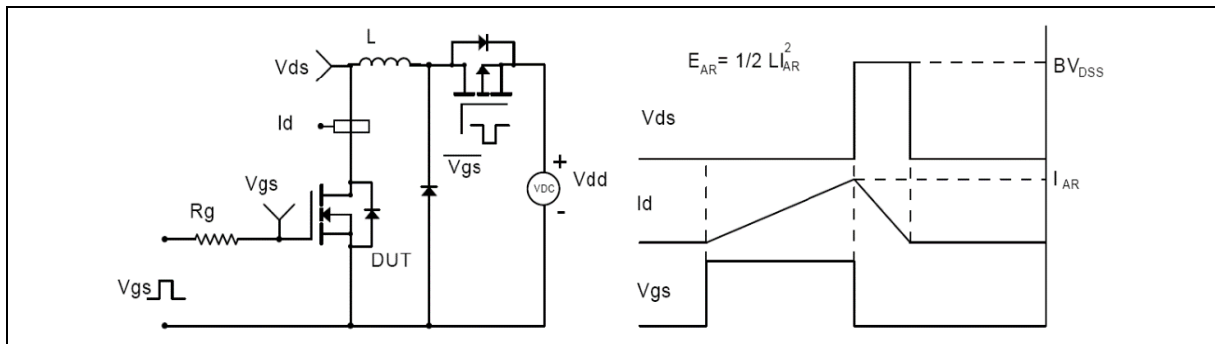

Figure 3. Unclamped inductive switching (UIS) test circuit & waveforms

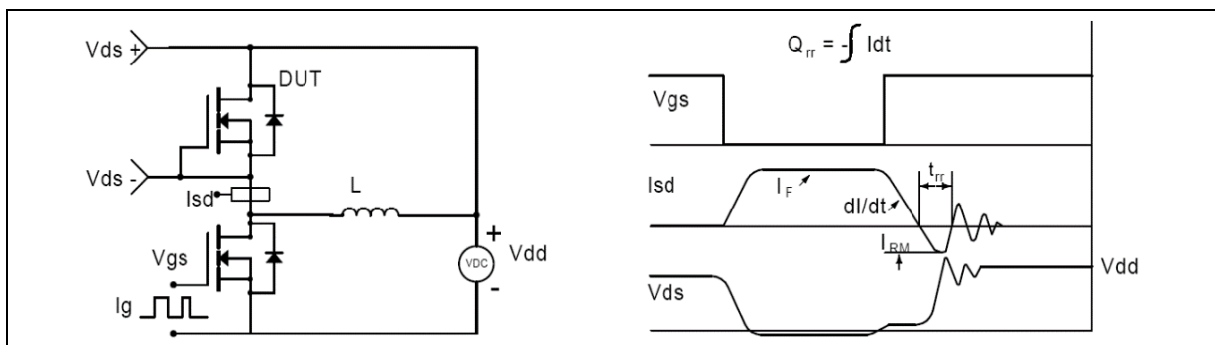
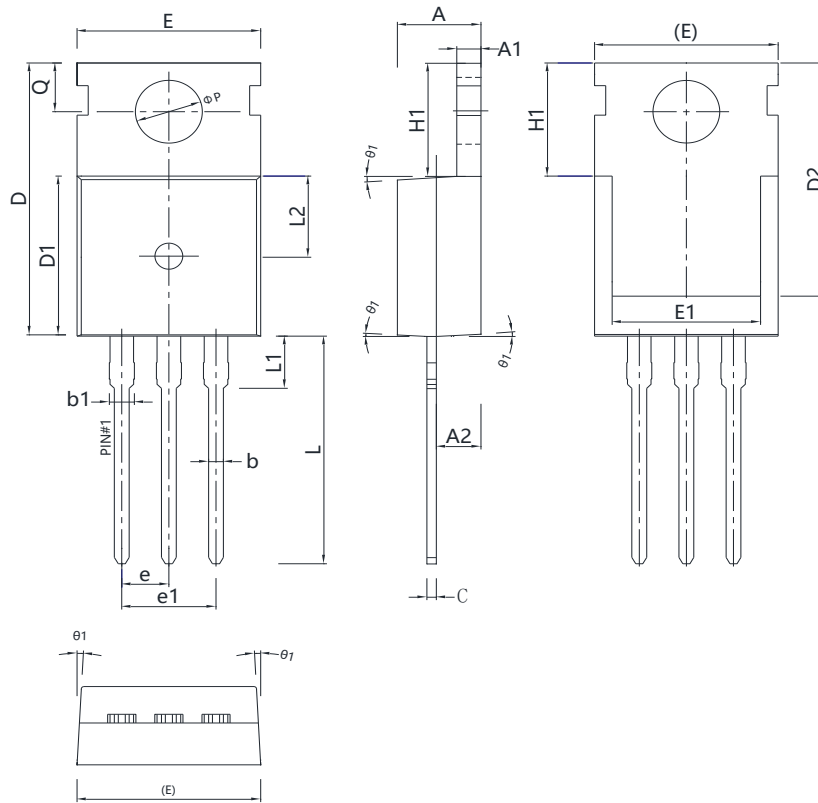

Figure 4. Diode reverse recovery test circuit & waveforms

Package Information



Symbol	mm		
	Min	Nom	Max
A	4.40	4.50	4.60
A1	1.27	1.30	1.33
A2	2.30	2.40	2.50
b	0.70	-	0.90
b1	1.27	-	1.40
c	0.45	0.50	0.60
D	15.30	15.70	16.10
D1	9.10	9.20	9.30
D2	13.10	-	13.70
E	9.70	9.90	10.20
E1	7.80	8.00	8.20
e	2.54BSC		
e1	5.08BSC		
H1	6.30	6.50	6.70
L	12.78	13.08	13.38
L1	-	-	3.50
L2	4.60REF		
ΦP	3.55	3.60	3.65
Q	2.73	-	2.87
θ1	1°	3°	5°

Version 1: TO220-J package outline dimension

Ordering Information

Package Type	Units/ Tube	Tubes/ Inner Box	Units/ Inner Box	Inner Boxes/ Carton Box	Units/ Carton Box
TO220-J	50	20	1000	5	5000

Product Information

Product	Package	Pb Free	RoHS	Halogen Free
OSG70R2K6PF	TO220	yes	yes	yes

Legal Disclaimer

The information given in this document shall in no event be regarded as a guarantee of conditions or characteristics. With respect to any examples or hints given herein, any typical values stated herein and/or any information regarding the application of the device, Oriental Semiconductor hereby disclaims any and all warranties and liabilities of any kind, including without limitation, warranties of non-infringement of intellectual property rights of any third party.

For further information on technology, delivery terms and conditions and prices, please contact the Oriental Semiconductor sales representatives (www.orientalsemi.com).

© Oriental Semiconductor Co.,Ltd. All Rights Reserved 