

### Features

- 600V Field Stop Trench IGBT Technology
- High Speed Switching
- Low Conduction Loss
- Positive Temperature Coefficient
- Easy Parallel Operation
- Short Circuit Withstanding Time 5 $\mu$ s
- 175°C Operating Temperature
- RoHS Compliant
- JEDEC Qualification

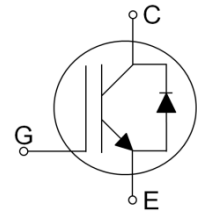
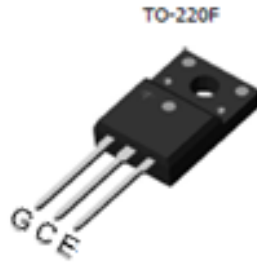

### Applications

Motor Drive, Air Conditioner, Inverter, Solar

Device	Package	Marking	Remark
TGPF20N60FDR	TO-220F	TGPF20N60FDR	RoHS

### Absolute Maximum Ratings

Parameter	Symbol	Value	Unit	
Collector-Emitter Voltage	$V_{CES}$	600	V	
Gate-Emitter Voltage	$V_{GES}$	$\pm 20$	V	
Continuous Collector Current	$I_C$	$T_C = 25\text{ }^\circ\text{C}$	40	A
		$T_C = 100\text{ }^\circ\text{C}$	20	A
Pulsed Collector Current (Note 1)	$I_{CM}$	60	A	
Diode Continuous Forward Current	$I_F$	20	A	
Diode Pulsed Forward Current (Note 1)	$I_{FM}$	100	A	
Power Dissipation	$P_D$	$T_C = 25\text{ }^\circ\text{C}$	48	W
		$T_C = 100\text{ }^\circ\text{C}$	24	W
Operating Junction Temperature	$T_{vj}$	-55 ~ 175	$^\circ\text{C}$	
Storage Temperature Range	$T_{STG}$	-55 ~ 150	$^\circ\text{C}$	
Maximum lead temperature for soldering purposes, 1/8" from case for 5 seconds	$T_L$	300	$^\circ\text{C}$	

Notes :

(1) Repetitive rating : Pulse width limited by maximum junction temperature

### Thermal Characteristics

Parameter	Symbol	Value	Unit
Maximum Thermal resistance, Junction-to-Case	$R_{\theta JC}$ (IGBT)	3.1	$^\circ\text{C/W}$
Maximum Thermal resistance, Junction-to-Case	$R_{\theta JC}$ (DIODE)	4.9	$^\circ\text{C/W}$
Maximum Thermal resistance, Junction-to-Ambient	$R_{\theta JA}$	62.5	$^\circ\text{C/W}$

### Electrical Characteristics of the IGBT $T_{vj}=25^{\circ}\text{C}$ , unless otherwise noted

Parameter	Symbol	Test condition	Min.	Typ.	Max.	Unit
<b>OFF</b>						
Collector – Emitter Breakdown Voltage	$BV_{CES}$	$V_{GE} = 0V, I_C = 1mA$	600	--	--	V
Zero Gate Voltage Collector Current	$I_{CES}$	$V_{CE} = 600V, V_{GE} = 0V$	--	--	1	mA
Gate – Emitter Leakage Current	$I_{GES}$	$V_{CE} = 0V, V_{GE} = \pm 20V$	--	--	$\pm 250$	nA
Integrated Gate Resistance	$R_{G(int)}$	$f = 1MHz, \text{Open Collector}$	--	9.5	--	$\Omega$
<b>ON</b>						
Gate – Emitter Threshold Voltage	$V_{GE(TH)}$	$V_{GE} = V_{CE}, I_C = 20mA$	4.5	6.0	7.5	V
Collector – Emitter Saturation Voltage	$V_{CE(SAT)}$	$V_{GE} = 15V, I_C = 20A, T_{vj} = 25^{\circ}\text{C}$	--	1.50	2.00	V
		$V_{GE} = 15V, I_C = 20A, T_{vj} = 125^{\circ}\text{C}$	--	1.75	--	
		$V_{GE} = 15V, I_C = 20A, T_{vj} = 175^{\circ}\text{C}$	--	1.85	--	V
<b>DYNAMIC</b>						
Input Capacitance	$C_{IES}$	$V_{CE} = 30V$ $V_{GE} = 0V$ $f = 1MHz$	--	1080	--	pF
Output Capacitance	$C_{OES}$		--	80	--	pF
Reverse Transfer Capacitance	$C_{RES}$		--	55	--	pF
Total Gate Charge	$Q_g$	$V_{CC} = 400V, I_C = 20A$ $V_{GE} = 15V$	--	102	153	nC
Gate-Emitter Charge	$Q_{ge}$		--	10	15	nC
Gate-Collector Charge	$Q_{gc}$		--	61	91	nC
<b>SWITCHING</b> (Note 2)						
Turn-On Delay Time	$t_{d(on)}$	$V_{CC} = 400V, I_C = 10A$ $R_G = 5\Omega, V_{GE} = 15V$ Inductive Load, $T_{vj} = 25^{\circ}\text{C}$	--	13	--	ns
Rise Time	$t_r$		--	9	--	ns
Turn-Off Delay Time	$t_{d(off)}$		--	140	--	ns
Fall Time	$t_f$		--	24	--	ns
Turn-On Switching Loss	$E_{ON}$		--	0.17	--	mJ
Turn-Off Switching Loss	$E_{OFF}$		--	0.12	--	mJ
Total Switching Loss	$E_{TS}$	--	0.29	--	mJ	
Turn-On Delay Time	$t_{d(on)}$	$V_{CC} = 400V, I_C = 20A$ $R_G = 5\Omega, V_{GE} = 15V$ Inductive Load, $T_{vj} = 25^{\circ}\text{C}$	--	14	--	ns
Rise Time	$t_r$		--	14	--	ns
Turn-Off Delay Time	$t_{d(off)}$		--	124	--	ns
Fall Time	$t_f$		--	28	--	ns
Turn-On Switching Loss	$E_{ON}$		--	0.34	0.51	mJ
Turn-Off Switching Loss	$E_{OFF}$		--	0.27	0.41	mJ
Total Switching Loss	$E_{TS}$	--	0.61	0.92	mJ	

### Electrical Characteristics of the IGBT $T_{vj}=25^{\circ}\text{C}$ , unless otherwise noted

Parameter	Symbol	Test condition	Min.	Typ.	Max.	Unit
<b>SWITCHING</b> (Note 2)						
Turn-On Delay Time	$t_{d(on)}$	$V_{CC} = 400\text{V}, I_C = 10\text{A}$ $R_G = 5\Omega, V_{GE} = 15\text{V}$ Inductive Load, $T_{vj} = 175^{\circ}\text{C}$	--	10	--	ns
Rise Time	$t_r$		--	13	--	ns
Turn-Off Delay Time	$t_{d(off)}$		--	173	--	ns
Fall Time	$t_f$		--	88	--	ns
Turn-On Switching Loss	$E_{ON}$		--	0.39	--	mJ
Turn-Off Switching Loss	$E_{OFF}$		--	0.24	--	mJ
Total Switching Loss	$E_{TS}$		--	0.63	--	mJ
Turn-On Delay Time	$t_{d(on)}$	$V_{CC} = 400\text{V}, I_C = 20\text{A}$ $R_G = 5\Omega, V_{GE} = 15\text{V}$ Inductive Load, $T_{vj} = 175^{\circ}\text{C}$	--	14	--	ns
Rise Time	$t_r$		--	16	--	ns
Turn-Off Delay Time	$t_{d(off)}$		--	155	--	ns
Fall Time	$t_f$		--	95	--	ns
Turn-On Switching Loss	$E_{ON}$		--	0.68	1.02	mJ
Turn-Off Switching Loss	$E_{OFF}$		--	0.51	0.77	mJ
Total Switching Loss	$E_{TS}$		--	1.19	1.79	mJ
Short Circuit Withstanding Time	$t_{SC}$	$V_{CC} = 300\text{V}, V_{GE} = 15\text{V}, T_{vj} = 125^{\circ}\text{C}$	5	--	--	$\mu\text{s}$

Notes :

(2) Not subject to production test – verified by design/characterization

### Electrical Characteristics of the DIODE $T_{vj}=25^{\circ}\text{C}$ , unless otherwise noted

Parameter	Symbol	Test condition	Min.	Typ.	Max.	Unit
Diode Forward Voltage	$V_{FM}$	$I_F = 10\text{A}, T_{vj} = 25^{\circ}\text{C}$	--	1.70	--	V
		$I_F = 10\text{A}, T_{vj} = 125^{\circ}\text{C}$	--	1.48	--	V
		$I_F = 10\text{A}, T_{vj} = 175^{\circ}\text{C}$	--	1.36	--	V
		$I_F = 20\text{A}, T_{vj} = 25^{\circ}\text{C}$	--	2.08	--	V
		$I_F = 20\text{A}, T_{vj} = 125^{\circ}\text{C}$	--	1.89	--	V
		$I_F = 20\text{A}, T_{vj} = 175^{\circ}\text{C}$	--	1.82	--	V
Reverse Recovery Time	$t_{rr}$	$I_F = 10\text{A},$ $di/dt = 200\text{A}/\mu\text{s},$ $T_{vj} = 25^{\circ}\text{C}$	--	48	--	ns
Reverse Recovery Current	$I_{rr}$		--	4.4	--	A
Reverse Recovery Charge	$Q_{rr}$		--	114	--	nC
Reverse Recovery Time	$t_{rr}$	$I_F = 10\text{A},$ $di/dt = 200\text{A}/\mu\text{s},$ $T_{vj} = 175^{\circ}\text{C}$	--	116	--	ns
Reverse Recovery Current	$I_{rr}$		--	9.0	--	A
Reverse Recovery Charge	$Q_{rr}$		--	612	--	nC
Reverse Recovery Time	$t_{rr}$	$I_F = 20\text{A},$ $di/dt = 200\text{A}/\mu\text{s},$ $T_{vj} = 25^{\circ}\text{C}$	--	52	--	ns
Reverse Recovery Current	$I_{rr}$		--	5.0	--	A
Reverse Recovery Charge	$Q_{rr}$		--	152	--	nC
Reverse Recovery Time	$t_{rr}$	$I_F = 20\text{A},$ $di/dt = 200\text{A}/\mu\text{s},$ $T_{vj} = 175^{\circ}\text{C}$	--	125	--	ns
Reverse Recovery Current	$I_{rr}$		--	10.2	--	A
Reverse Recovery Charge	$Q_{rr}$		--	780	--	nC

### IGBT Characteristics

Fig. 1 IGBT Output Characteristics

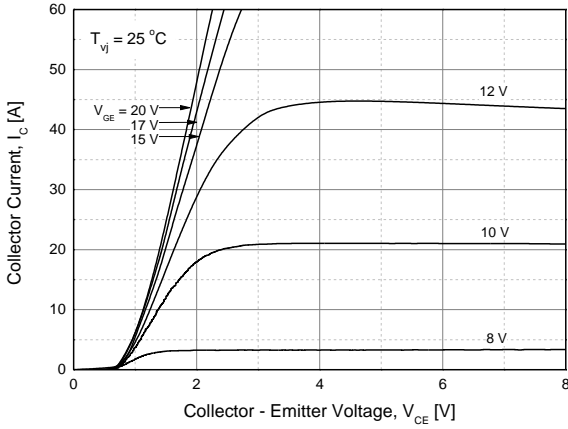

Fig. 2 IGBT Output Characteristics

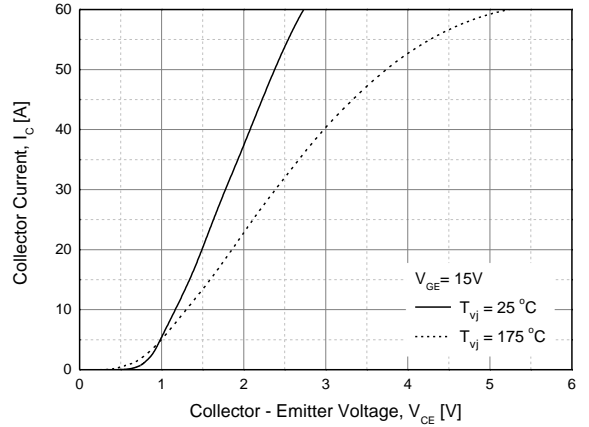

Fig. 3 IGBT Saturation Voltage vs. Junction Temperature

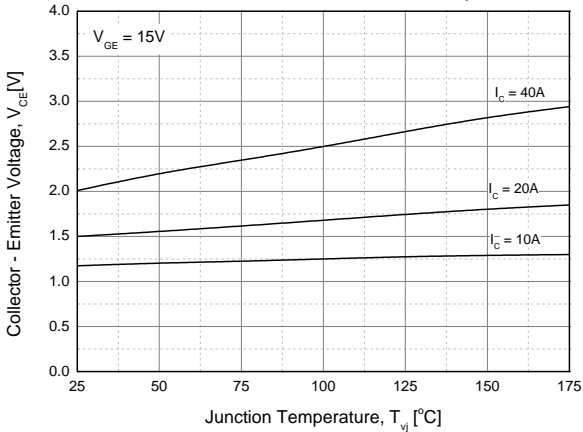

Fig. 4 IGBT Saturation Voltage vs. Gate Bias

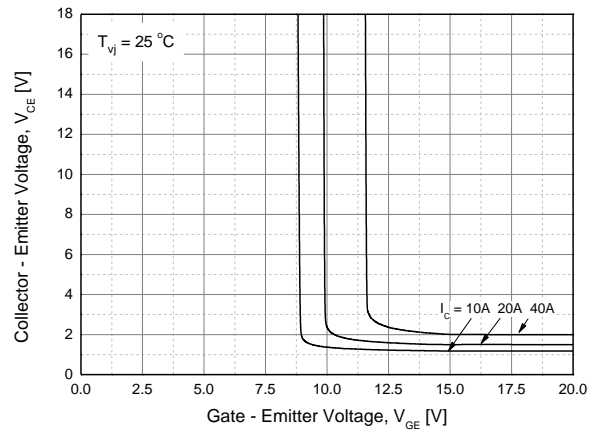

Fig. 5 IGBT Saturation Voltage vs. Gate Bias

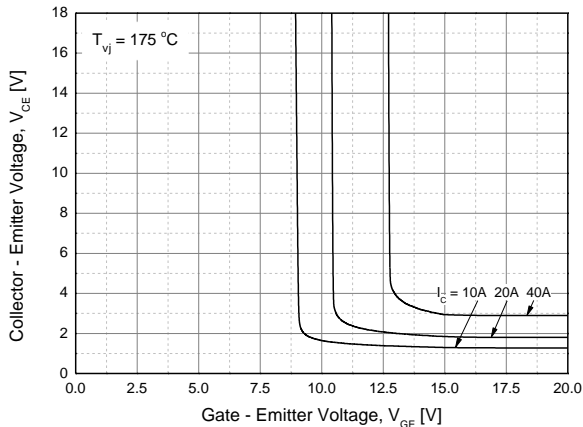
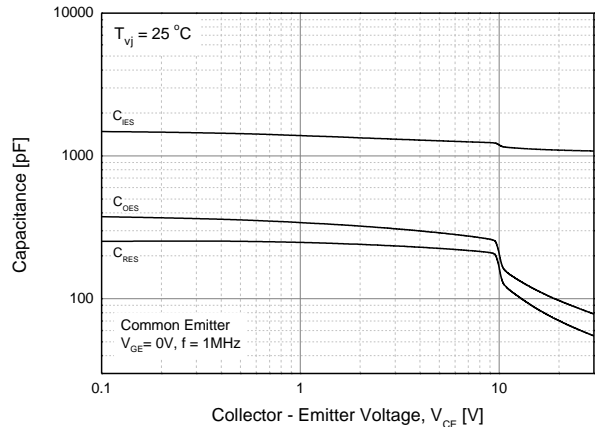

Fig. 6 IGBT Capacitance Characteristics



### IGBT Characteristics

Fig. 7 Turn-on Time vs. Gate Resistor

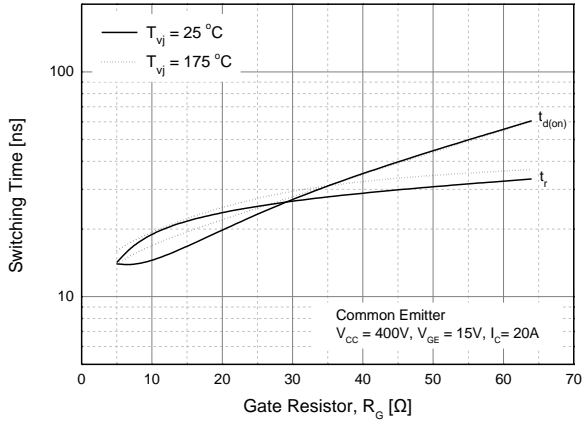

Fig. 8 Turn-off Time vs. Gate Resistor

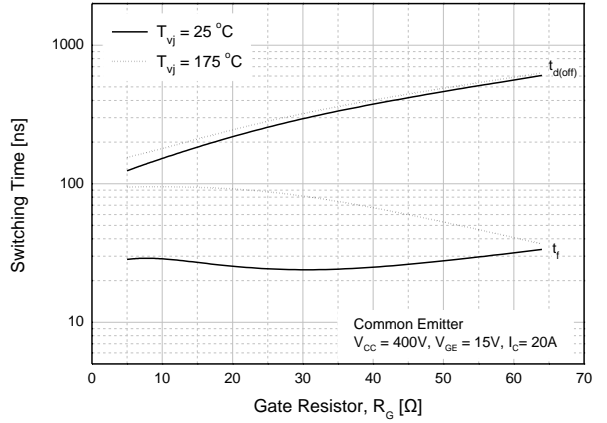

Fig. 9 Switching Loss vs. Gate Resistor

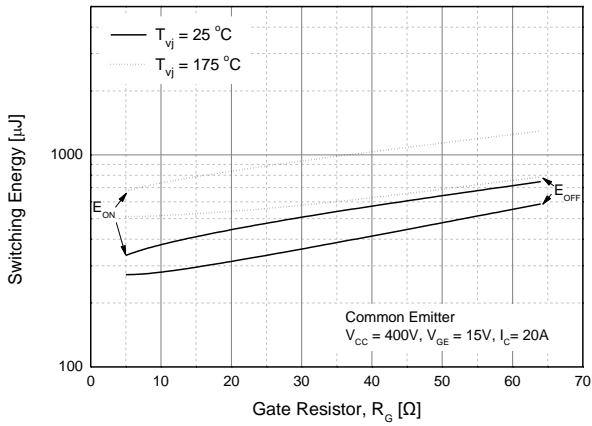

Fig. 10 Turn-on Time vs. Collector Current

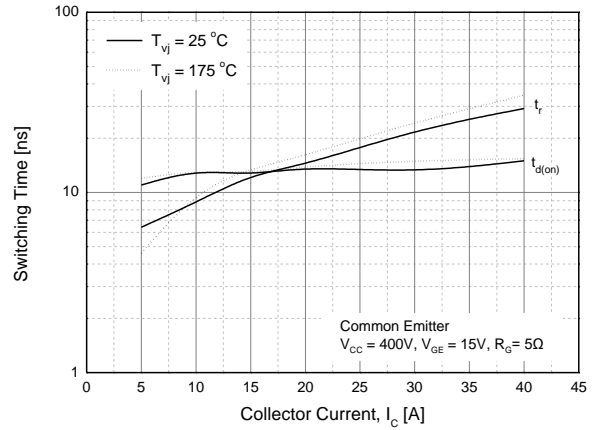

Fig. 11 Turn-off Time vs. Collector Current

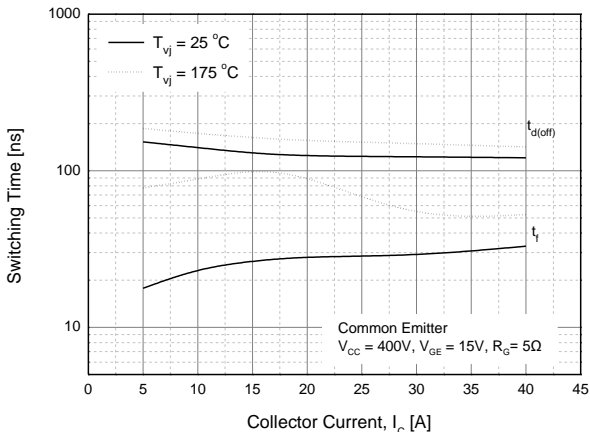
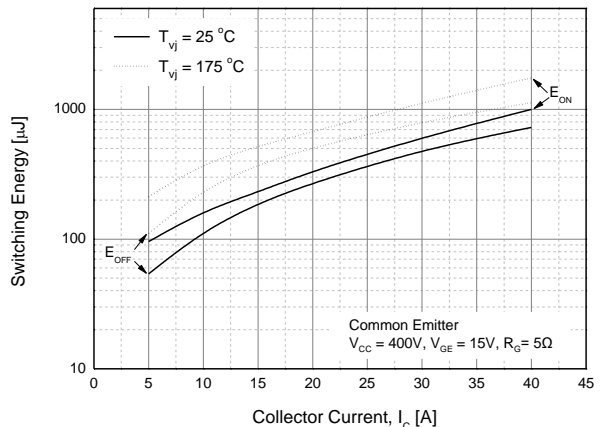

Fig. 12 Switching Loss vs. Collector Current



**IGBT Characteristics**

Fig. 13 Gate Charge Characteristics

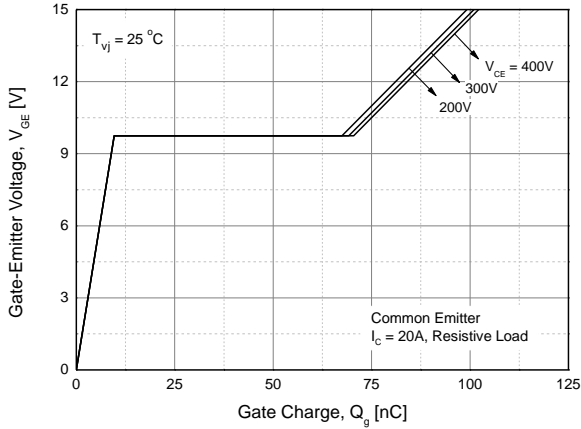

Fig. 14 SOA

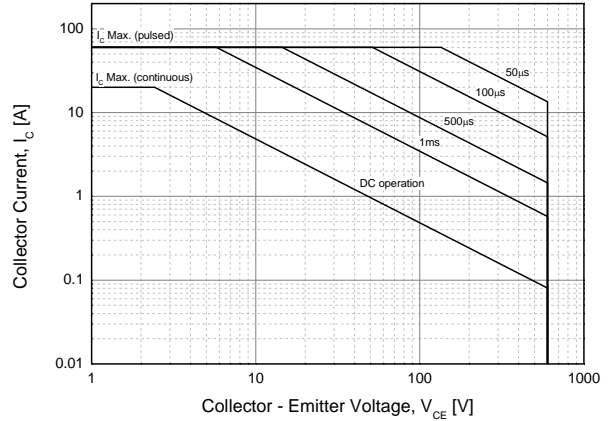

Fig. 15 RBSOA

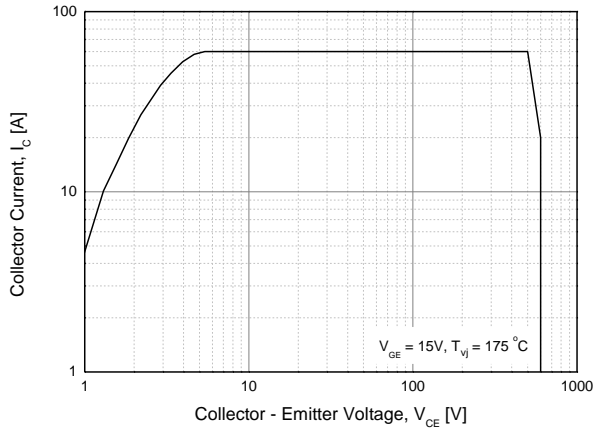

Fig. 16 Transient Thermal Impedance of IGBT

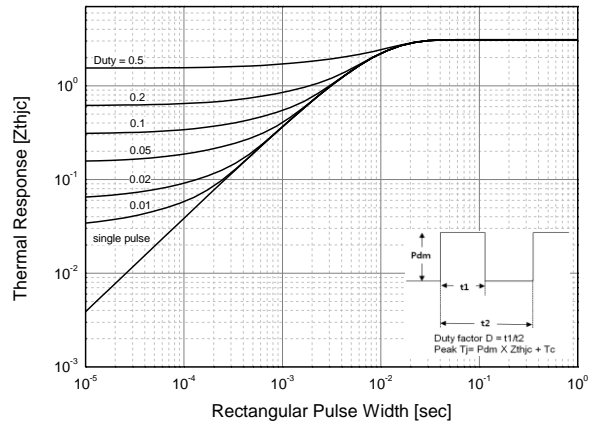
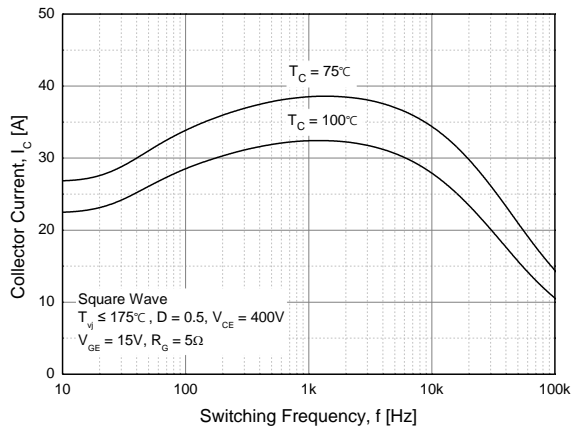

Fig. 17 Load Current vs. Frequency



## DIODE Characteristics

Fig. 18 Diode Conduction Characteristics

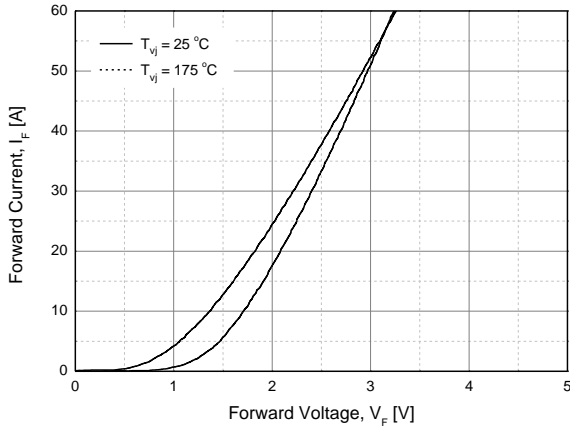

Fig. 19 Reverse Recovery Current vs. Forward Current

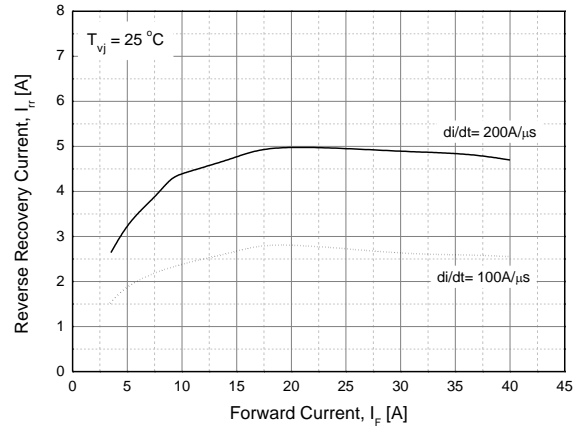

Fig. 20 Reverse Recovery Charge vs. Forward Current

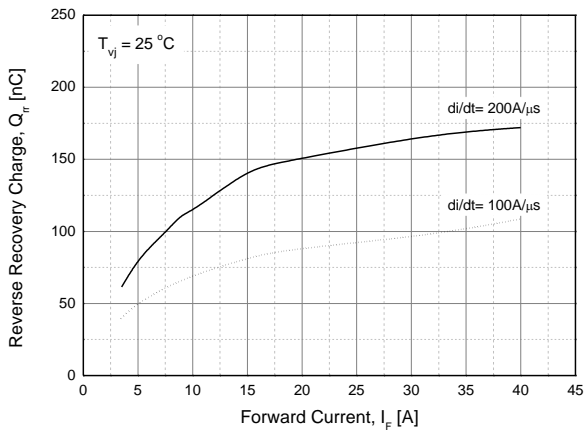
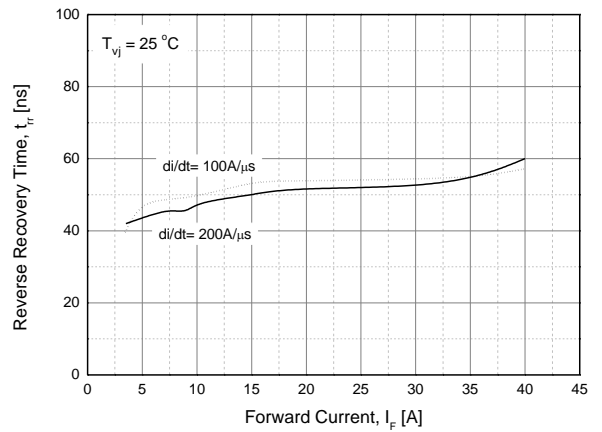
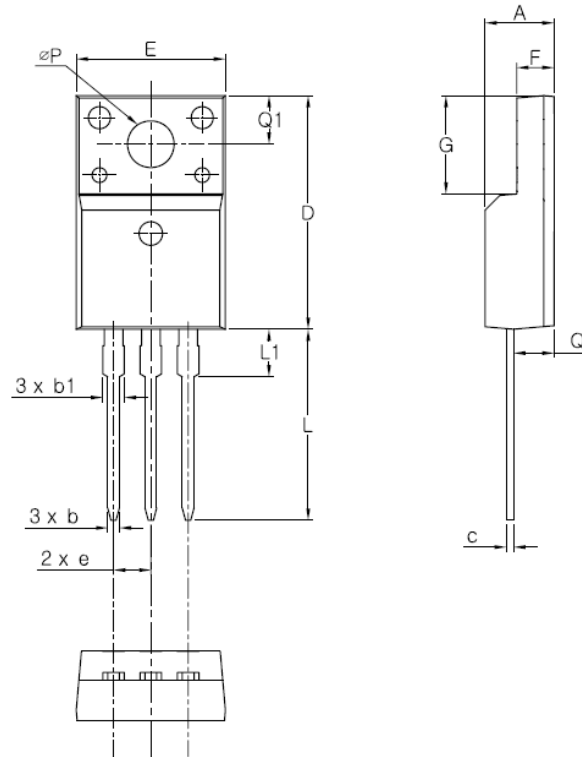

Fig. 21 Reverse Recovery Time vs. Forward Current





**TO-220F-3L MECHANICAL DATA**



SYMBOL	MIN	MAX
A	4.50	4.93
b	0.70	0.91
b1	1.15	1.47
c	0.36	0.60
D	15.67	16.07
E	6.96	10.36
e	2.54 BSC	
F	2.34	2.74
G	6.48	6.90
L	12.37	13.18
L1	2.23	3.43
Q	2.56	2.96
Q1	3.10	3.50
ØP	2.98	3.38

**Disclaimer**

TRinno technology reserves the right to make changes without notice to products herein to improve reliability, performance, or design. The information given in this document is believed to be accurate and reliable. However, it shall in no event be regarded as a guarantee of conditions and characteristics. With respect to any information regarding the application of the device, TRinno technology hereby disclaims any and all warranties and liabilities of any kind, including without limitation, warranties of non-infringement of patent rights of any third party.