

60V N-Ch Power MOSFET
Feature

- ◇ High Speed Power Switching, Logic Level
- ◇ Enhanced Body diode dv/dt capability
- ◇ Enhanced Avalanche Ruggedness
- ◇ 100% UIS Tested, 100% Rg Tested
- ◇ Lead Free, Halogen Free

V_{DS}		60	V
$R_{DS(on),typ}$	$V_{GS}=10V$	7.3	m Ω
$R_{DS(on),typ}$	$V_{GS}=4.5V$	10	m Ω
I_D (Silicon Limited)		61	A
I_D (Package Limited)		40	A

Application

- ◇ Synchronous Rectification in SMPS
- ◇ Hard Switching and High Speed Circuit
- ◇ DC/DC in Telecoms and Industrial

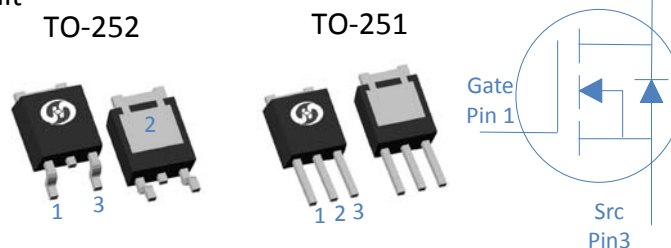

Part Number	Package	Marking
HGI090N06SL	TO-251	GI090N06SL
HGD090N06SL	TO-252	GD090N06SL

Absolute Maximum Ratings at $T_j=25^\circ\text{C}$ (unless otherwise specified)

Parameter	Symbol	Conditions	Value	Unit
Continuous Drain Current (Silicon Limited)	I_D	$T_C=25^\circ\text{C}$	61	A
		$T_C=100^\circ\text{C}$	43	
		Continuous Drain Current (Package Limited)	$T_C=25^\circ\text{C}$	
Drain to Source Voltage	V_{DS}	-	60	V
Gate to Source Voltage	V_{GS}	-	± 20	V
Pulsed Drain Current	I_{DM}	-	270	A
Avalanche Energy, Single Pulse	E_{AS}	$L=0.4\text{mH}, T_C=25^\circ\text{C}$	20	mJ
Power Dissipation	P_D	$T_C=25^\circ\text{C}$	75	W
Operating and Storage Temperature	T_J, T_{stg}	-	-55 to 175	$^\circ\text{C}$

Absolute Maximum Ratings

Parameter	Symbol	Max	Unit
Thermal Resistance Junction-Ambient	$R_{\theta JA}$	65	$^\circ\text{C/W}$
Thermal Resistance Junction-Case	$R_{\theta JC}$	2	$^\circ\text{C/W}$

Electrical Characteristics at $T_J=25^{\circ}\text{C}$ (unless otherwise specified)
Static Characteristics

Parameter	Symbol	Conditions	Value			Unit
			min	typ	max	
Drain to Source Breakdown Voltage	$V_{(BR)DSS}$	$V_{GS}=0V, I_D=250\mu A$	60	-	-	V
Gate Threshold Voltage	$V_{GS(th)}$	$V_{GS}=V_{DS}, I_D=250\mu A$	1.0	1.8	2.4	
Zero Gate Voltage Drain Current	I_{DSS}	$V_{GS}=0V, V_{DS}=60V, T_J=25^{\circ}\text{C}$	-	-	1	μA
		$V_{GS}=0V, V_{DS}=60V, T_J=100^{\circ}\text{C}$	-	-	100	
Gate to Source Leakage Current	I_{GSS}	$V_{GS}=\pm 20V, V_{DS}=0V$	-	-	± 100	nA
Drain to Source on Resistance	$R_{DS(on)}$	$V_{GS}=10V, I_D=20A$	-	7.3	9	m Ω
		$V_{GS}=4.5V, I_D=20A$	-	10.0	13	
Transconductance	g_{fs}	$V_{DS}=5V, I_D=20A$	-	26	-	S
Gate Resistance	R_G	$V_{GS}=0V, V_{DS}$ Open, $f=1\text{MHz}$	-	1.5	-	Ω

Dynamic Characteristics

Input Capacitance	C_{iss}	$V_{GS}=0V, V_{DS}=30V, f=1\text{MHz}$	-	1620	-	pF
Output Capacitance	C_{oss}		-	415	-	
Reverse Transfer Capacitance	C_{rss}		-	3	-	
Total Gate Charge	$Q_g(10V)$	$V_{DD}=30V, I_D=20A, V_{GS}=10V$	-	24	-	nC
Total Gate Charge	$Q_g(4.5V)$		-	12	-	
Gate to Source Charge	Q_{gs}		-	5.0	-	
Gate to Drain (Miller) Charge	Q_{gd}		-	3.0	-	
Turn on Delay Time	$t_{d(on)}$	$V_{DD}=30V, I_D=20A, V_{GS}=10V,$ $R_G=10\Omega,$	-	9	-	ns
Rise time	t_r		-	4	-	
Turn off Delay Time	$t_{d(off)}$		-	29	-	
Fall Time	t_f		-	4	-	

Reverse Diode Characteristics

Diode Forward Voltage	V_{SD}	$V_{GS}=0V, I_F=20A$	-	0.9	1.2	V
Reverse Recovery Time	t_{rr}	$V_R=30V, I_F=20A, di_F/dt=300A/\mu s$	-	30	-	ns
Reverse Recovery Charge	Q_{rr}		-	43	-	nC

Fig 1. Typical Output Characteristics

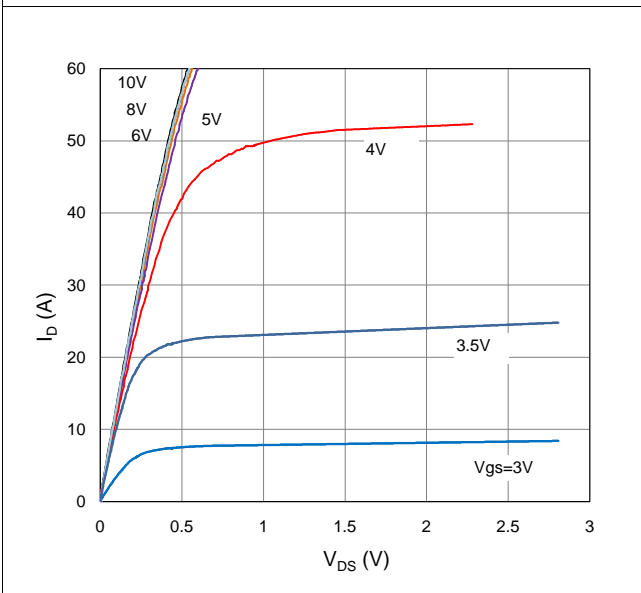

Figure 2. On-Resistance vs. Gate-Source Voltage

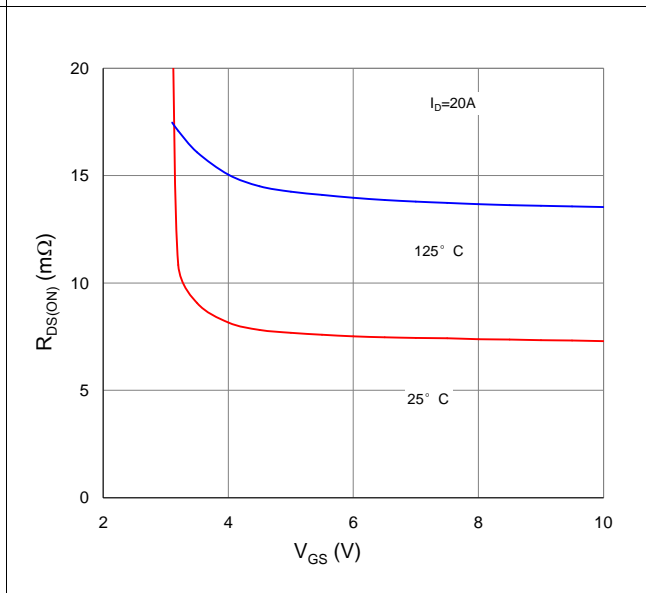

Figure 3. On-Resistance vs. Drain Current and Gate Voltage

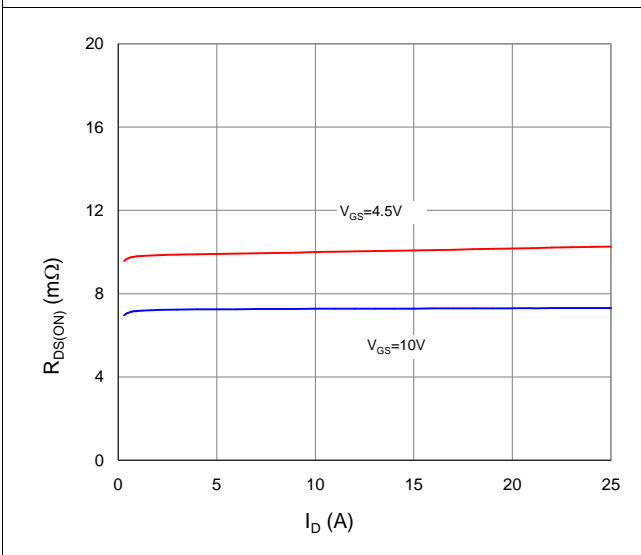

Figure 4. Normalized On-Resistance vs. Junction Temperature

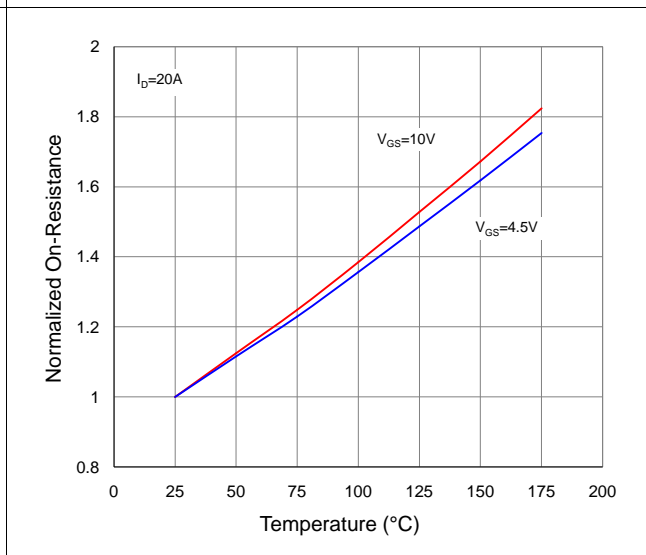

Figure 5. Typical Transfer Characteristics

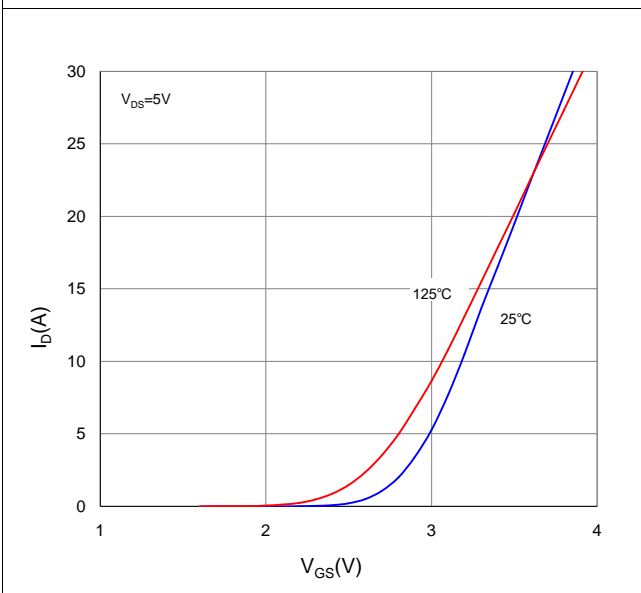

Figure 6. Typical Source-Drain Diode Forward Voltage

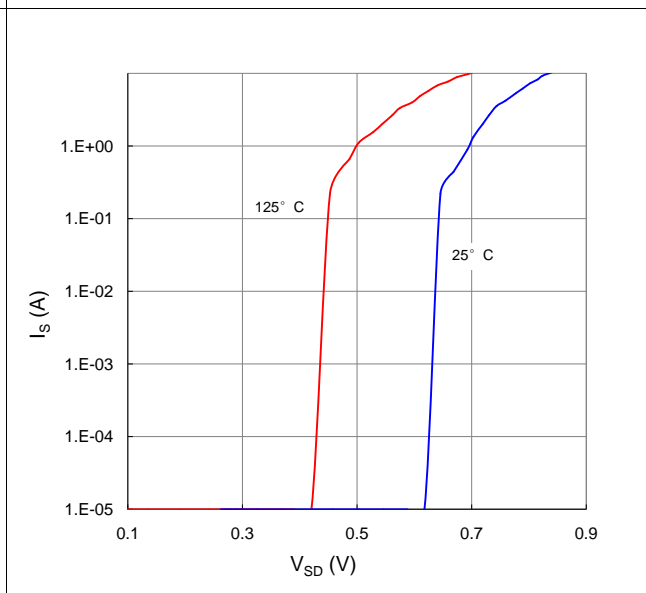

Figure 7. Typical Gate-Charge vs. Gate-to-Source Voltage

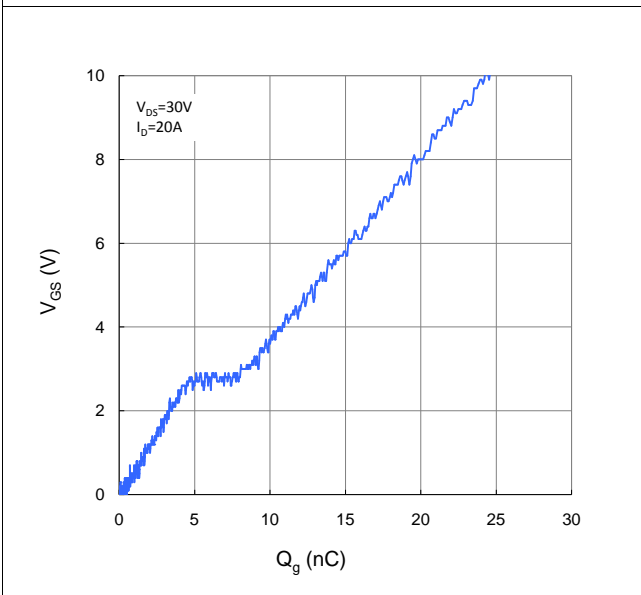

Figure 8. Typical Capacitance vs. Drain-to-Source Voltage

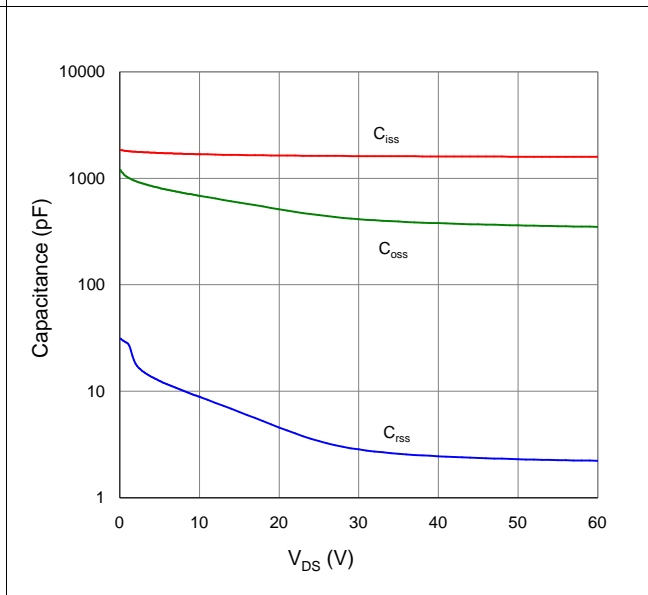

Figure 9. Maximum Safe Operating Area

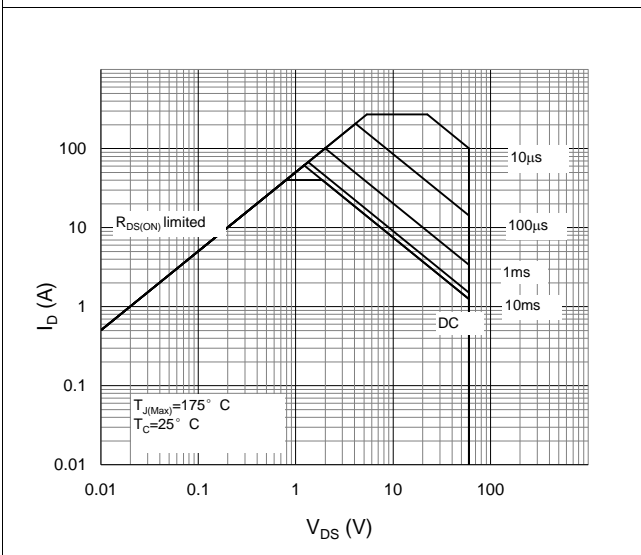

Figure 10. Maximum Drain Current vs. Case Temperature

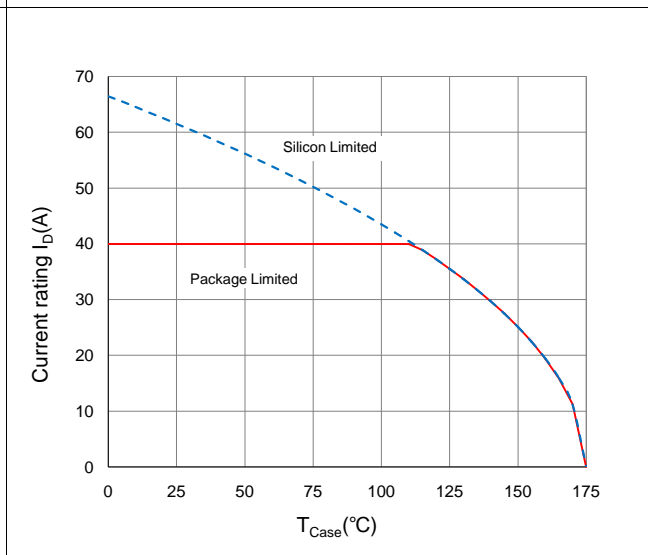
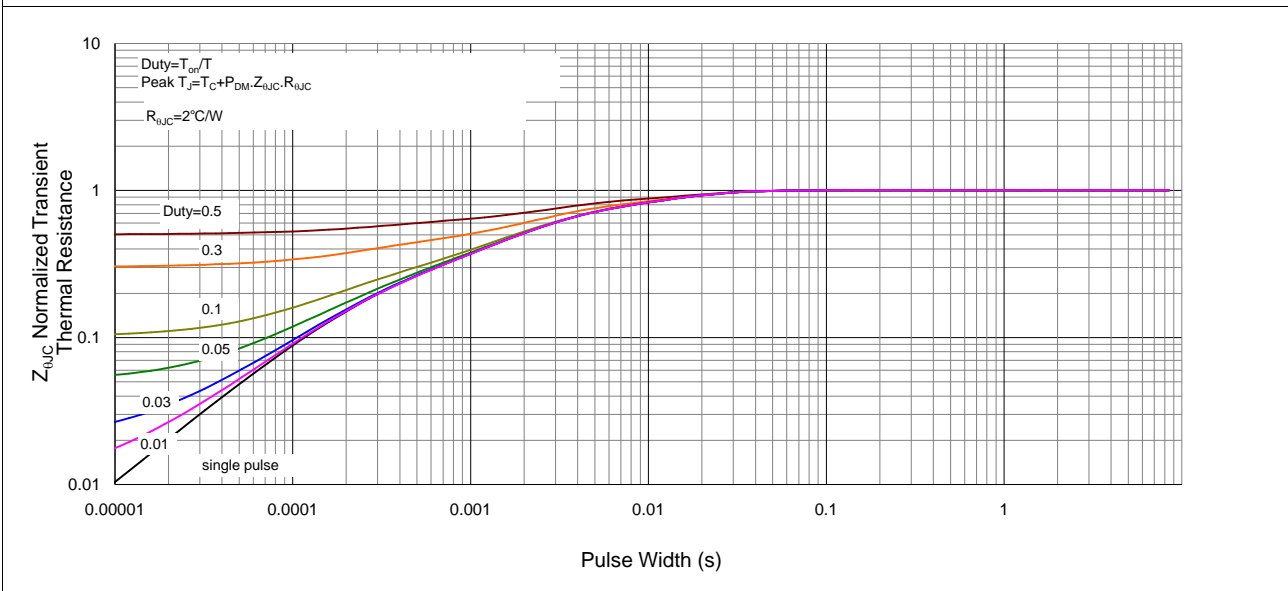
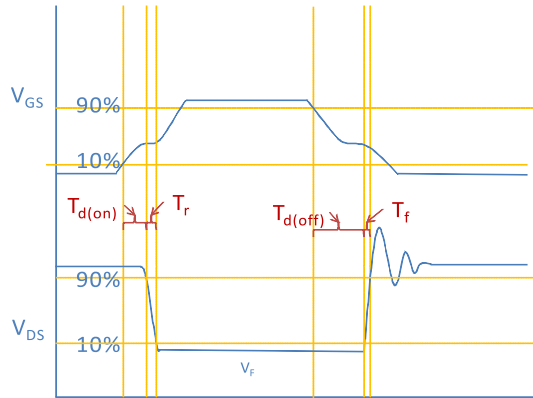

Figure 11. Normalized Maximum Transient Thermal Impedance, Junction-to-Case



Inductive switching Test



Gate Charge Test

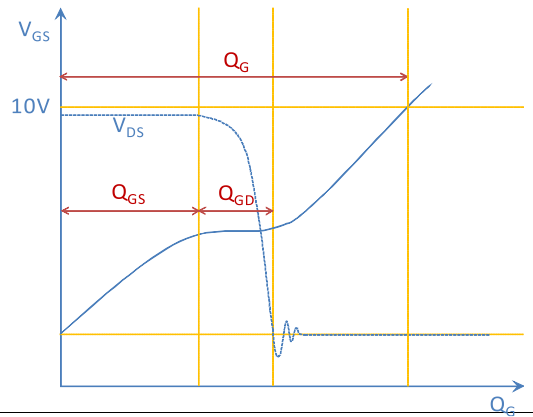
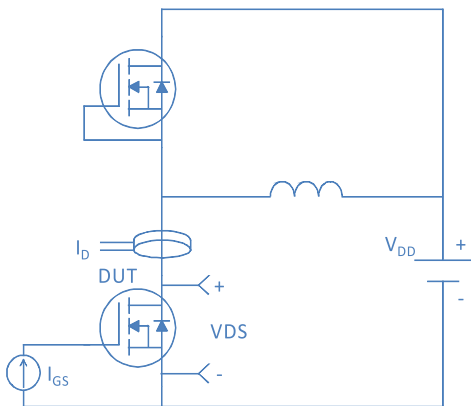

Uclamped Inductive Switching (UIS) Test

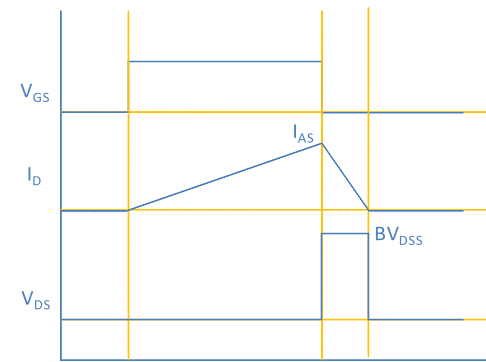

Diode Recovery Test

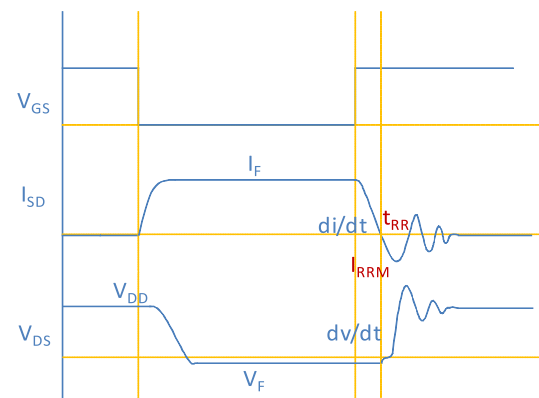

Package Outline

TO-251, 3 leads

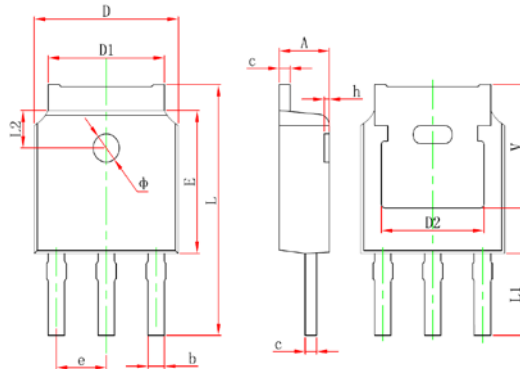

Symbol	Dimensions In Millimeters		Dimensions In Inches	
	Min.	Max.	Min.	Max.
A	2.200	2.400	0.087	0.094
b	0.660	0.860	0.026	0.034
c	0.460	0.580	0.018	0.023
D	6.500	6.700	0.256	0.264
D1	5.100	5.460	0.201	0.215
D2	4.830 REF.		0.190 REF.	
E	6.000	6.200	0.236	0.244
e	2.186	2.386	0.086	0.094
L	10.400	11.000	0.409	0.433
L1	3.500 REF.		0.138 REF.	
L2	1.600 REF.		0.063 REF.	
Φ	1.100	1.300	0.043	0.051
h	0.000	0.300	0.000	0.012
V	5.350 REF.		0.211 REF.	

TO-252, 2 leads

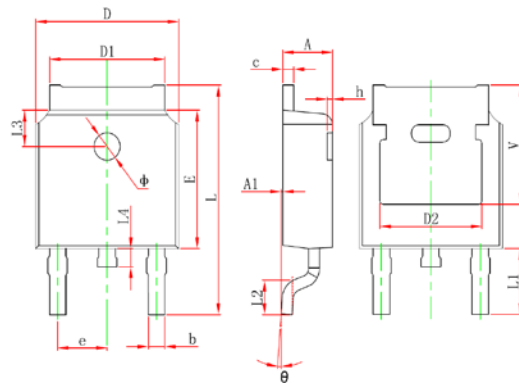

Symbol	Dimensions In Millimeters		Dimensions In Inches	
	Min.	Max.	Min.	Max.
A	2.200	2.400	0.087	0.094
A1	0.000	0.127	0.000	0.005
b	0.660	0.860	0.026	0.034
c	0.460	0.580	0.018	0.023
D	6.500	6.700	0.256	0.264
D1	5.100	5.460	0.201	0.215
D2	4.830 REF.		0.190 REF.	
E	6.000	6.200	0.236	0.244
e	2.186	2.386	0.086	0.094
L	9.800	10.400	0.386	0.409
L1	2.900 REF.		0.114 REF.	
L2	1.400	1.700	0.055	0.067
L3	1.600 REF.		0.063 REF.	
L4	0.600	1.000	0.024	0.039
Φ	1.100	1.300	0.043	0.051
θ	0°	8°	0°	8°
h	0.000	0.300	0.000	0.012
V	5.350 REF.		0.211 REF.	