

## 120V N-Ch Power MOSFET

### Feature

- ◇ High Speed Power Switching
- ◇ Enhanced Body diode dv/dt capability
- ◇ Enhanced Avalanche Ruggedness
- ◇ 100% UIS Tested, 100% Rg Tested
- ◇ Lead Free

### Application

- ◇ Synchronous Rectification in SMPS
- ◇ Hard Switching and High Speed Circuit
- ◇ Power Tools
- ◇ UPS
- ◇ Motor Control

$V_{DS}$		120	V
$R_{DS(on),typ}$	TO-262	8.6	mΩ
$I_D$ (Silicon Limited)		109	A

TO-262

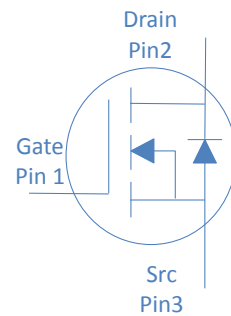
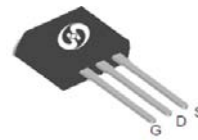

Part Number	Package	Marking
HGW100N12S	TO-262	GW100N12S

### Absolute Maximum Ratings at $T_J=25^\circ\text{C}$ (unless otherwise specified)

Parameter	Symbol	Conditions	Value	Unit
Continuous Drain Current (Silicon Limited)	$I_D$	$T_C=25^\circ\text{C}$	109	A
		$T_C=100^\circ\text{C}$	77	
Drain to Source Voltage	$V_{DS}$	-	120	V
Gate to Source Voltage	$V_{GS}$	-	$\pm 20$	V
Pulsed Drain Current	$I_{DM}$	-	300	A
Avalanche Energy, Single Pulse	$E_{AS}$	$L=0.4\text{mH}, T_C=25^\circ\text{C}$	320	mJ
Power Dissipation	$P_D$	$T_C=25^\circ\text{C}$	214	W
Operating and Storage Temperature	$T_J, T_{stg}$	-	-55 to 175	$^\circ\text{C}$

### Absolute Maximum Ratings

Parameter	Symbol	Max	Unit
Thermal Resistance Junction-Case	$R_{\theta JC}$	0.7	$^\circ\text{C/W}$
Thermal Resistance Junction-Ambient	$R_{\theta JA}$	50	$^\circ\text{C/W}$

## Electrical Characteristics at $T_j=25^\circ\text{C}$ (unless otherwise specified)

### Static Characteristics

Parameter	Symbol	Conditions	Value			Unit
			min	typ	max	
Drain to Source Breakdown Voltage	$V_{(BR)DSS}$	$V_{GS}=0V, I_D=250\mu A$	120	-	-	V
Gate Threshold Voltage	$V_{GS(th)}$	$V_{GS}=V_{DS}, I_D=250\mu A$	2	3	4	
Zero Gate Voltage Drain Current	$I_{DSS}$	$V_{GS}=0V, V_{DS}=120V, T_j=25^\circ\text{C}$	-	-	1	$\mu A$
		$V_{GS}=0V, V_{DS}=120V, T_j=100^\circ\text{C}$	-	-	100	
Gate to Source Leakage Current	$I_{GSS}$	$V_{GS}=\pm 20V, V_{DS}=0V$	-	-	$\pm 100$	nA
Drain to Source on Resistance	$R_{DS(on)}$	$V_{GS}=10V, I_D=20A$ TO-262	-	8.6	10	$m\Omega$
Transconductance	$g_{fs}$	$V_{DS}=5V, I_D=20A$	-	65	-	S
Gate Resistance	$R_G$	$V_{GS}=0V, V_{DS}$ Open, $f=1\text{MHz}$	-	3.5	-	$\Omega$

### Dynamic Characteristics

Input Capacitance	$C_{iss}$	$V_{GS}=0V, V_{DS}=60V, f=1\text{MHz}$	-	4470	-	$\mu F$
Output Capacitance	$C_{oss}$		-	235	-	
Reverse Transfer Capacitance	$C_{rss}$		-	9.5	-	
Total Gate Charge	$Q_g$	$V_{DD}=60V, I_D=20A, V_{GS}=10V$	-	56	-	nC
Gate to Source Charge	$Q_{gs}$		-	18	-	
Gate to Drain (Miller) Charge	$Q_{gd}$		-	6	-	
Turn on Delay Time	$t_{d(on)}$	$V_{DD}=60V, I_D=20A, V_{GS}=10V, R_G=10\Omega,$	-	16	-	ns
Rise time	$t_r$		-	21	-	
Turn off Delay Time	$t_{d(off)}$		-	38	-	
Fall Time	$t_f$		-	19	-	

### Reverse Diode Characteristics

Diode Forward Voltage	$V_{SD}$	$V_{GS}=0V, I_F=20A$	-	0.9	1.2	V
Reverse Recovery Time	$t_{rr}$	$V_R=60V, I_F=20A, dI_F/dt=500A/\mu s$	-	70	-	ns
Reverse Recovery Charge	$Q_{rr}$		-	600	-	nC

Fig 1. Typical Output Characteristics

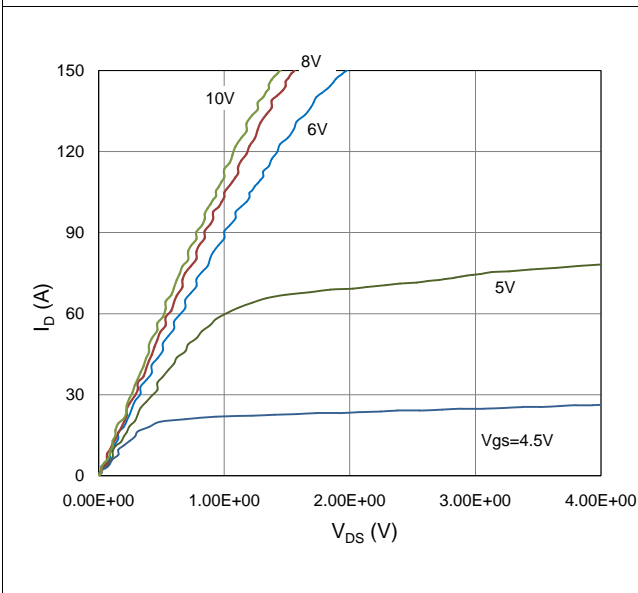

Figure 2. On-Resistance vs. Gate-Source Voltage

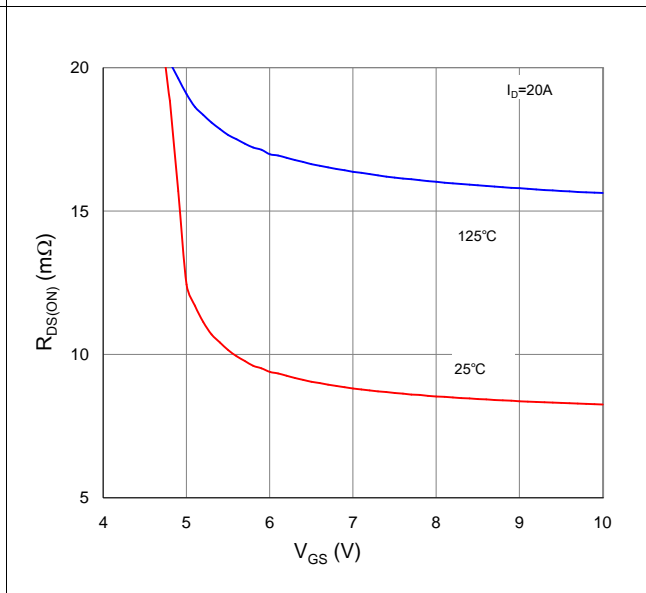

Figure 3. On-Resistance vs. Drain Current and Gate Voltage

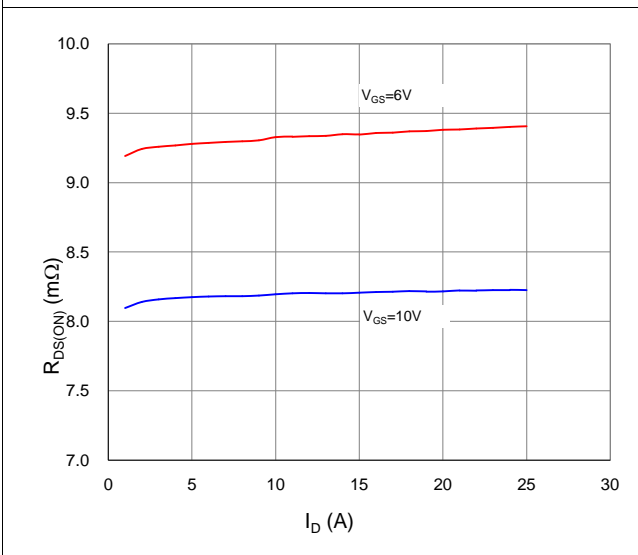

Figure 4. Normalized On-Resistance vs. Junction Temperature

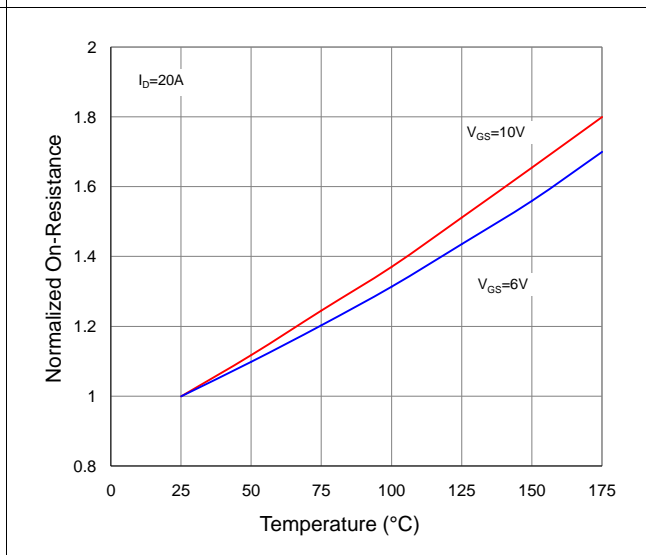

Figure 5. Typical Transfer Characteristics

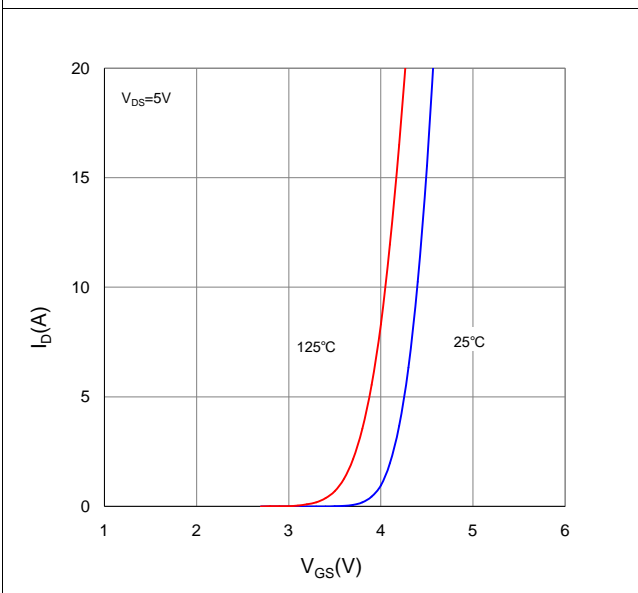

Figure 6. Typical Source-Drain Diode Forward Voltage

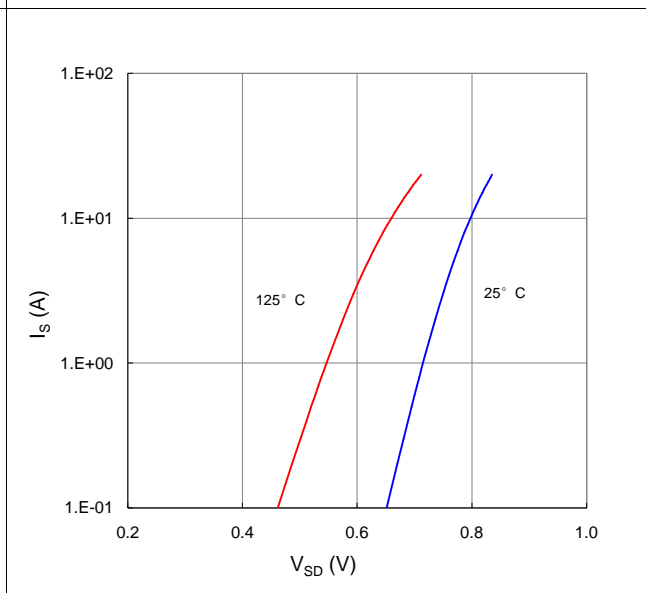

Figure 7. Typical Gate-Charge vs. Gate-to-Source Voltage

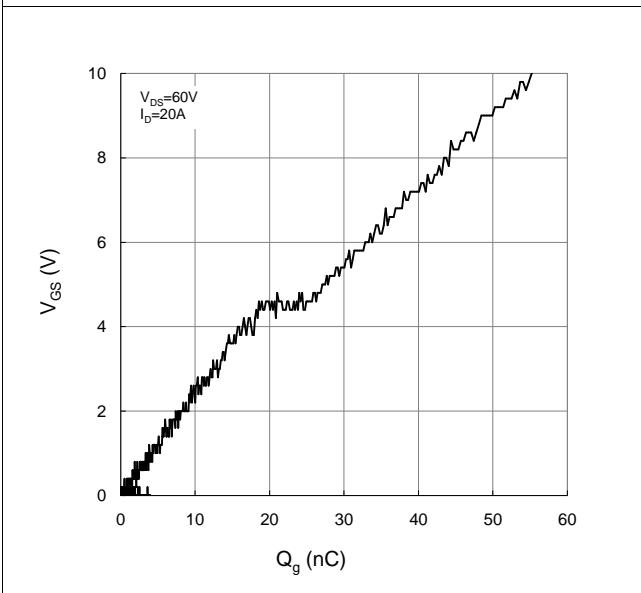

Figure 8. Typical Capacitance vs. Drain-to-Source Voltage

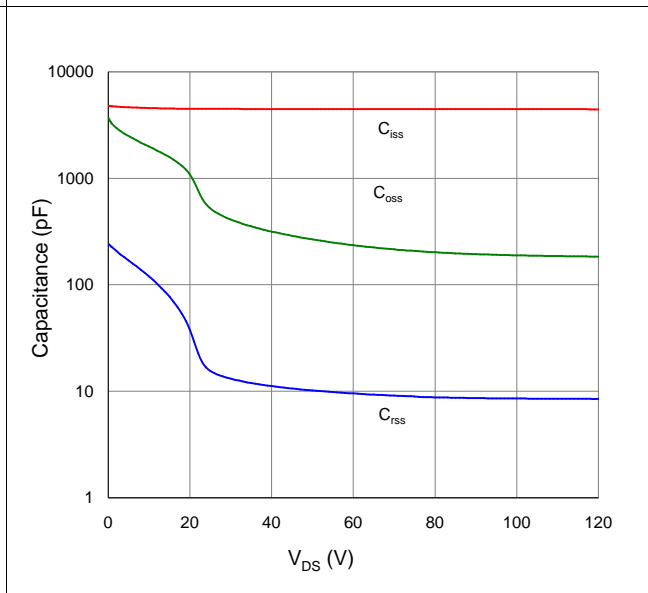

Figure 9. Maximum Safe Operating Area

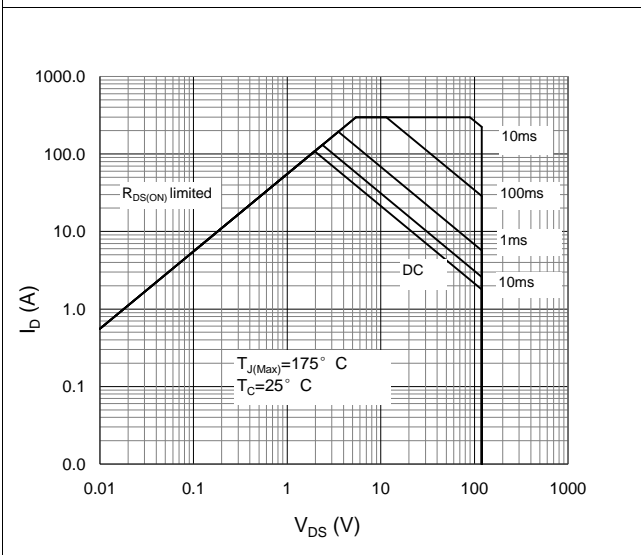

Figure 10. Maximum Drain Current vs. Case Temperature

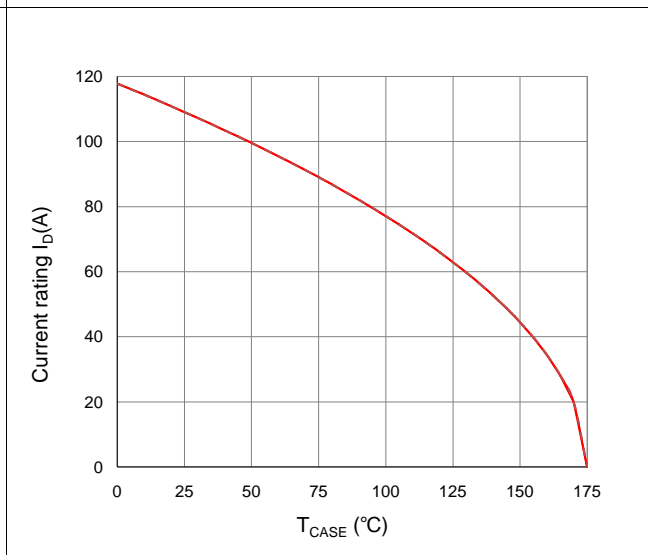
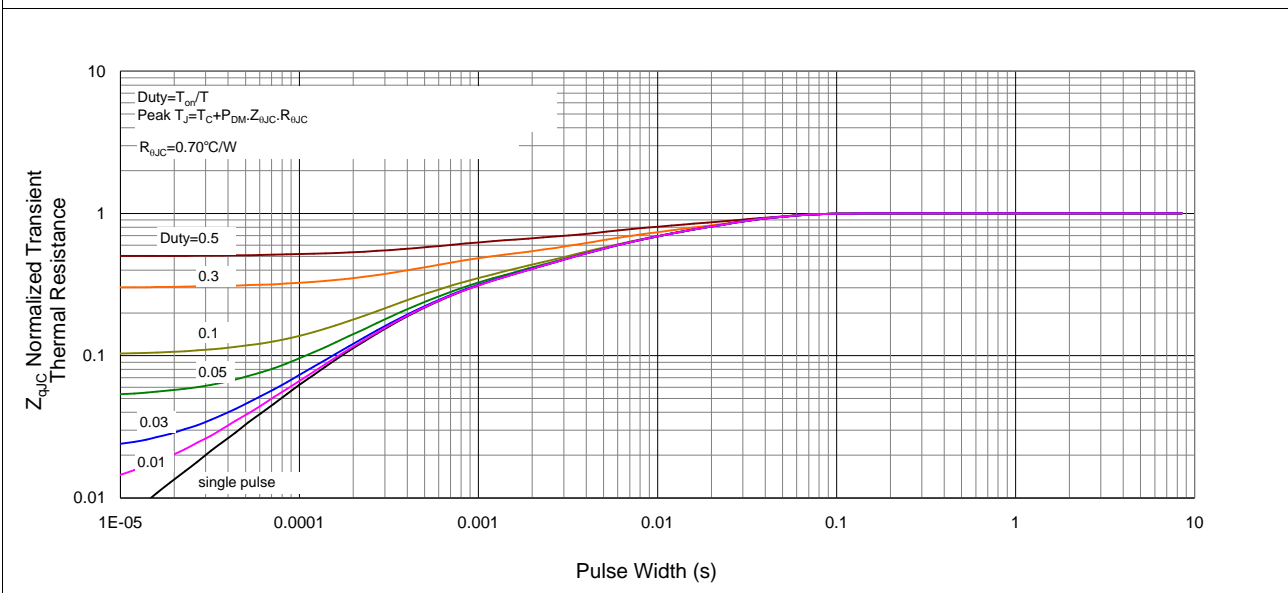
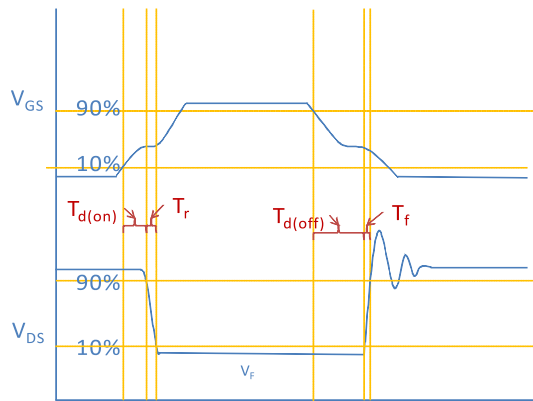

Figure 11. Normalized Maximum Transient Thermal Impedance, Junction-to-Case



### Inductive switching Test



### Gate Charge Test

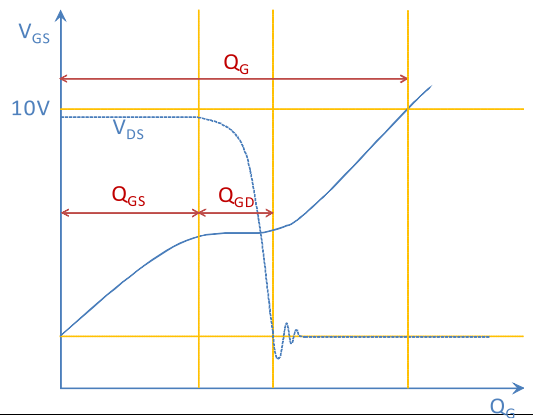

### Uclamped Inductive Switching (UIS) Test

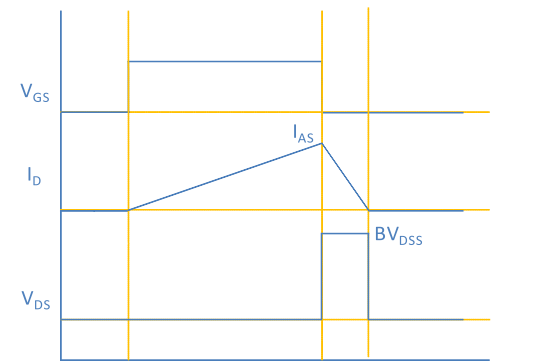

### Diode Recovery Test

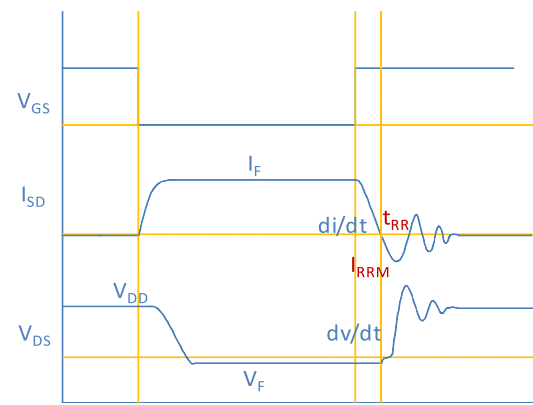

## Package Outline

TO-262, 3 leads

Unit: mm

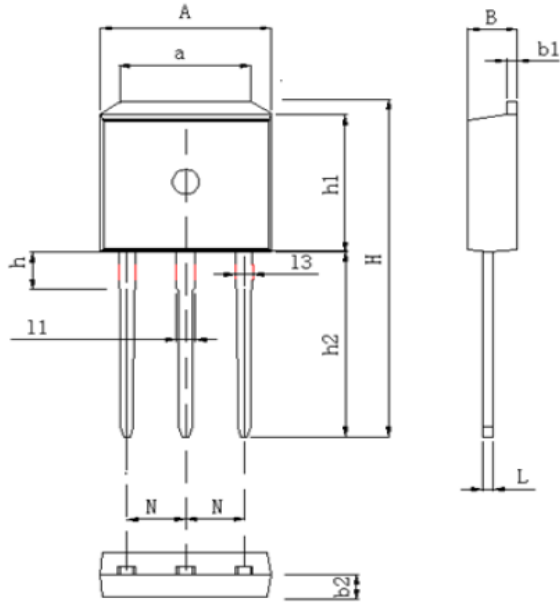

DIM	MILLIMETERS
A	9.98±0.2
a	7.4±0.4
B	4.5±0.2
b1	1.3±0.05
b2	2.4±0.2
H	23.9±0.3
h	3.1±0.2
h1	9.16±0.2
h2	13.2±0.2
L	0.5±0.1
l1	1.3±0.1
l2	0.8±0.1
N	2.45±0.1